



# ***A Series Temperature Controller Instruction Sheet***

***Thank you very much for purchasing DELTA A Series. Please read this instruction sheet to ensure correct use before using your A series and please keep this instruction sheet handy for quick reference whenever necessary.***

## **Notice:**



### **DANGER! Caution! Electric Shock!**

1. Do not touch the AC terminals while the power is supplied to the controller in order to avoid any electric shock.
2. Make sure the power is disconnected while checking the unit inside



### **WARNING!**





**This controller is an open-type temperature controller. Make sure to evaluate any dangerous application in which a serious human injury or serious property damage may occur.**

1. Please use the specified solderless terminals (M3 screw, Max. width is 7.2mm or less) and tighten them properly.
2. Do not allow the dust or metal fragments to fall inside the controller. These may cause malfunction.
3. Never modify or disassemble the controller.
4. Do not wire to the No function terminals.
5. Make sure all wires are connected to the correct polarity of terminals.
6. Do not install and/or use the controller in places subject to:
  - Dust or corrosive gases and liquid.
  - High humidity.
  - High radiation.
  - Vibration and shock
  - High voltage and high frequency
7. Must turn off the power when wiring and changing temperature sensor.
8. Be sure to use compensating wires that match the thermocouple types when extending or connecting the thermocouple wires.
9. Please use wires with resistance when extending or connecting the wires of the platinum resistance thermometer (RTD).
10. Please keep the wire route as short as possible when wiring platinum resistance thermometer (RTD) to the controller and please route power wires as far away as possible from load wires to avoid interferences and noise affection.
11. This controller is an open-type unit and it must be placed in an enclosure away from high temperature, humidity, dripping water, corrosive materials, airborne dust and electric shock or vibration.
12. This controller is an open-type unit and it must be placed in an enclosure away from high temperature, humidity, dripping water, corrosive materials, airborne dust and electric shock or vibration

13. Please make sure the power and signal instrument are all installed properly before the power is supplied to the controller, otherwise these may cause serious damage.
14. Please do not touch the terminals of the controller or repair the controller when the power is supplied to the controller, otherwise these may cause electric shock.
15. Wait one minute after the power is disconnected for capacitors to discharge and please do not touch any internal circuit within the waiting period.
16. Cleaning: Do not use acid and alkaline liquid. Please use soft, dry cloth to clean the controller.

## ■ Names of Parts



- **PV Display:** to display the process value or parameter type.
- **SV Display:** to display set point, parameter operation read value, manipulated variable or set value of the parameter.
- **AT LED** : flashes when the Auto-tuning operation is ON.
- **OUT LED** : lights when the output is ON.
-  : **Function key.** Press this key to select the desired function mode.
-  : **Mode key.** Press this key to set parameters within each function mode.
- °C, °F : **Temperature unit LEDs.** °C LED lights when this parameter is configured for Celsius and °F LED lights when this parameter is configured for Fahrenheit.
- **ALM1/ALM2 : Alarm output LED.** The ALM1 and ALM2 LED lights when Alarm 1/Alarm 2 output is ON.
-  : **Up key.** Press this key to increase values displayed on the SV display. Holding down this key speeds up the continuously increments.
-  : **Down key.** Press this key to decrease values displayed on the SV display. Holding down this key speeds up the continuously decrements.

## ■ Model Explanation

DTA

①                      ②                      ③                      ④

① Series	DTA : Delta A Series Temperature Controller	
② Panel Size (W × H)	4848 : W48 × H48mm 4896 : W48 × H96mm	7272 : W72 × H72mm 9696 : W96 × H96mm
③ Output Selection	R : Relay output V : Voltage Pulse output C : Current output (Control)	SPDT (4848 series is SPST), 250VAC, 5A 14V+10% ~ -20%(Max. 40mA) 4~20mA
④ Communication Selection	0 : non-communication function 1 : with RS-485 function	

## ■ Electric Specifications

Power Supply Voltage	100 to 240VAC 50/60Hz
Operation Voltage Range	85% to 110% of rated voltage
Power Consumption	5VA
Display Method	7-segment digit LED Display Process value (PV): Red color, Set point (SV): Green color
Input Temperature Sensor	Thermocouple: K, J, T, E, N, R, S, B
	Platinum resistance thermometer (RTD): Pt100, JPt100
Control Method	PID or ON/OFF control or manual tuning
Control Output	Relay output: SPDT (4848 series is SPST), 250VAC, 5A
	Voltage Pulse output: DC 14V, Max. load current 40mA
	Current output: 4 to 20mADC (Load resistance: Max. 600Ω)
Display Accuracy	0.1% of measuring range
Sampling Time	0.5 sec
Vibration Resistance	10 to 55Hz, 10m/s <sup>2</sup> for 10min, each in X, Y and Z directions
Shock Resistance	Max. 300m/s <sup>2</sup> , 3 times in each 3 axes, 6 directions
Operation Temperature	0°C to 50°C
Storage Temperature	-20°C to +65°C
Installation Site Altitude	10000ft.
Ambient Humidity	35% to 85% RH (non-condensing)















## ■ Parameters List

### 1. Operation function mode: Perform per the settings of related control parameters





LED Display	Explanation	Default
	RUN/STOP: Control setting begins. Run (run) or Stop (stop) mode on the SV display.	RUN
	ALARM1 HIGH: Upper-limit alarm 1	4.0°C
	ALARM1 LOW: Lower-limit alarm 1	4.0°C
	ALARM2 HIGH: Upper-limit alarm 2	4.0°C
	ALARM2 LOW: Lower-limit alarm 2	4.0°C
	Setting lock: Lock 1 (LoL1), Lock 2 (LoL2) or OFF (off) on the SV display. Lock 1 mode can lock all settings and Lock 2 mode only can lock others than SV value. When OFF mode is selected, the Lock function will be OFF. If you press  and  key simultaneously, the "Lock" status can be released and the controller will be back to the previous display.	OFF

LED Display	Explanation	Default
	OUT: Output value display and output value adjustment in manual tuning control (This function is not available in ON/OFF control or Auto-tuning setting)	0

## 2. Regulation function mode: Set the control parameters

LED Display	Explanation	Default
	AT: Auto-tuning setting. When AT key is set to ON (  ) , the execution of the PID auto-tuning function is automatically started. (PID control)	OFF
	P: Proportional Band (PID control)	2.1
	I: Integral Time (PID control)	260
	D: Derivative Time (PID control)	41
	PdoF: Offset output when P or PD control function is ON. (PID control and Ki=0)	0
	ioF: Default value of integral volume when PID control function is ON and integral time constant is not equal to 0(zero). AT can automatically set this parameter. (PID control and Ki≠0)	0
	HTS: Set Heating hysteresis when ON/OFF control function is ON.	0
	CTS: Set Cooling hysteresis when ON/OFF control function is ON.	0
	HTPD: PID heating control cycle setting (PID control)	Output Selection: C, V : 4 sec R : 20 sec
	CLPD: PID cooling control cycle setting (PID control)	
	TPOF: Regulate temperature deviation value	0
	CRHI: Regulate 20mA output deviation value	0
	CRLO: Regulate 4mA output deviation value	0

## 3. Initial setting function mode: Initial settings of the controller and communication parameters

LED Display	Explanation	Default
	INPUT: Select input temperature sensor type (Please refer to the contents of the “Temperature Sensor Type and Temperature Range” for detail)	PT2
	UNIT: Select temperature display unit, °C (  ) and °F (  ) .	C





LED Display	Explanation	Default
	T-HIGH: Upper-limit of temperature range	500.0
	T-LOW: Lower-limit of temperature range	-20.0
	CONTROL: Control method setting. PID (), ON/OFF control (), or manual tuning ( ) on the SV display	PID
	SWITCH: Select Heating () or Cooling () mode	HEAT
	AL1 SET: Alarm 1 setting	0
	AL2 SET: Alarm 2 setting	0
	C WE: Communication write in function disable/enable	OFF
	C NO: Communication address setting	1
	BPS: Communication baud rate setting	9600
	LENGTH: Communication data length setting	7
	PARITY: Communication parity bit setting	E
	STOP BIT: Communication stop bit setting	1

Note: Alarm settings should be set under initial setting function mode and then AL1H, AL1L, AL2H and AL2L settings would be able to display in operation function mode.













































## ■ Operation Explanation























There are three function modes of operation: operation, regulation and initial setting. When you turn the power on, the operation function mode will be displayed. If key is pressed is pressed for one time, it will switch to the regulation function mode. If key is pressed for more than 3 seconds, it will switch to the initial setting function mode. If key is pressed for one time while in the regulation function mode or initial setting function mode, it will return to the operation function mode.

PV/SV: Set the temperature set point and display process temperature. Use to set the temperature set point.

Setting method: In operation function mode, regulation function mode and initial function setting mode, press  key to select desired function and use   key to change settings. After the settings are completely changed, press  key to save. Flow chart of settings and internal functions are shown as below:



















Regulation function mode	Operation function mode	Initial setting function mode
<b>At</b> Auto-tuning is ON (In PID control or RUN mode) Press  	<b>1234</b> Use   to set temperature of target Press  	<b>LnPt</b> Set input type Press  
<b>P</b> Set PID Kp (In PID control) Press  	<b>r-s</b> Control setting RUN or STOP Press  	<b>tPUn</b> Set temperature unit Press  
<b>L</b> Set PID Ki (In PID control) Press  	<b>AL 1H</b> Upper-limit alarm 1 (This parameter is available only when ALA1 function enables) Press  	<b>tP-H</b> Set upper-limit of temperature range Press  
<b>d</b> Set PID Kd (In PID control) Press  	<b>AL 1L</b> Lower-limit alarm 1 (This parameter is available only when ALA1 function enables) Press  	<b>tP-L</b> Set lower-limit of temperature range Press  
<b>PdoF</b> or <b>ioF</b> P/PD control Offset setting (When PID control is ON and Ki=0, set the value of PdoF; If Ki≠0, AT will automatically set the value of ioF) Press  	<b>AL 2H</b> Upper-limit alarm 2 (This parameter is available only when ALA2 function enables) Press  	<b>Ctrl</b> Select control method Press  
<b>HtS</b> or <b>CtS</b> Heating/Cooling hysteresis (In ON/OFF control) Press  	<b>AL 2L</b> Lower-limit alarm 2 (This parameter is available only when ALA2 function enables) Press  	<b>S-HC</b> Select heating/cooling functions Press  
<b>HtPd</b> or <b>CLPd</b> Set Heating/Cooling control cycle (In PID control) Press  	<b>LoC</b> Setting lock mode Press  	<b>ALA 1</b> Alarm 1 setting Press  

Regulation function mode	Operation function mode	Initial setting function mode
<b>tPof</b> Regulate temperature deviation value Press  	<b>out</b> Output value display and adjust Press   Return to temperature display	<b>ALAZ</b> Alarm 2 setting Press  
<b>CrHc</b> Regulate 20mA output deviation value (Display when current output) Press  		<b>CoSH</b> Communication write in disable/enable (only available when the controller has RS-485 function) Press  
<b>CrLo</b> Regulate 4mA output deviation value (Display when current output) Press   Return to auto-tuning setting		<b>C-no</b> Communication address setting (only available when the controller has RS-485 function) Press  
		<b>bPS</b> Communication baud rate setting (only available when the controller has RS-485 function) Press  
		<b>LEn</b> Communication data length setting (only available when the controller has RS-485 function) Press  
		<b>PrtY</b> Communication parity bit setting (only available when the controller has RS-485 function) Press  
		<b>StoP</b> Communication stop bit setting (only available when the controller has RS-485 function) Press   Return to input type setting



## ■ Heating and Cooling Functions

There are two functions to control temperature, heater and cooler. The heating function actuates when the process temperature (PV) is getting down and the cooling function cools when the process temperature is getting high. It is impossible to operate both functions simultaneously in this controller, therefore only one function can be selected and it is either heating function or cooling function.

## ■ Temperature Sensor Type and Temperature Range

Input Temperature Sensor Type	Register Value	LED Display	Temperature Range
Platinum resistance (Pt100) type3	15		0.0 to 100.0°C
Platinum resistance (Pt100) type2	14		-20.0 to 500.0°C
Platinum resistance (Pt100) type1	13		-200 to 600°C
Platinum resistance (JPt100) type2	12		0.0 to 100.0°C
Platinum resistance (JPt100) type1	11		-20.0 to 400.0°C
Thermocouple (TC) B type	10		100 to 1800°C
Thermocouple (TC) S type	9		0 to 1700°C
Thermocouple (TC) R type	8		0 to 1700°C
Thermocouple (TC) N type	7		-200 to 1300°C
Thermocouple (TC) E type	6		0 to 600°C
Thermocouple (TC) T type2	5		-20.0 to 400.0°C
Thermocouple (TC) T type1	4		-200 to 400°C
Thermocouple (TC) J type2	3		-20.0 to 400.0°C
Thermocouple (TC) J type1	2		-100 to 850°C
Thermocouple (TC) K type2	1		-20.0 to 500.0°C
Thermocouple (TC) K type1	0		-200 to 1300°C

## ■ Input Error Indication

Setting value	Temperature sensor is not connected	Measured temperature exceeds temperature range	Unknown input
PV			



Setting value	Temperature sensor is not connected	Measured temperature exceeds temperature range	Unknown input
SV			

## ■ Alarm Outputs

There are two groups of alarm outputs and each group can select ten alarm types in the initial setting function mode. The alarm output is activated when the temperature of target (PV) is getting higher or lower than set value (SV).

Set Value	Alarm Type	Alarm Output Function
0	Alarm function disabled	Output OFF
1	Deviation upper- and lower-limit: This alarm output operates when PV value is higher than set value of SV+(AL-H) or lower than set value of SV-(AL-L).	<p>ON OFF SV-(AL-L) SV SV+(AL-H)</p>
2	Deviation upper-limit: This alarm output operates when PV value is higher than set value of SV+(AL-H).	<p>ON OFF SV SV+(AL-H)</p>
3	Deviation lower-limit: This alarm output operates when PV value is lower than set value of SV-(AL-L).	<p>ON OFF SV-(AL-L) SV</p>
4	Reverse deviation upper- and lower-limit: This alarm output operates when PV value is in the range of set value of SV+(AL-H) and SV-(AL-L).	<p>ON OFF SV-(AL-L) SV SV+(AL-H)</p>
5	Absolute value upper- and lower-limit: This alarm output operates when PV value is higher than set value of AL-H or lower than set value of AL-L.	<p>ON OFF AL-L 0 AL-H</p>
6	Absolute value upper-limit: This alarm output operates when PV value is higher than set value of AL-H.	<p>ON OFF 0 AL-H</p>
7	Absolute value lower-limit: This alarm output operates when PV value is lower than set value of AL-L.	<p>ON OFF AL-L 0</p>
8	Deviation upper- and lower-limit with standby sequence: This alarm output operates when PV value reaches set value (SV value) and the value is higher than set value of SV+(AL-H) or lower than set value of SV-(AL-L).	<p>ON OFF SV-(AL-L) SV SV+(AL-H)</p>
9	Deviation upper-limit with standby sequence: This alarm output operates when PV value reaches set value (SV value) and the reached value is higher than set value of SV+(AL-H).	<p>ON OFF SV SV+(AL-H)</p>

Set Value	Alarm Type	Alarm Output Function
10	Deviation lower-limit with standby sequence: This alarm output operates when PV value reaches the set value (SV value) and the reached value is lower than set value of SV-(AL-L).	

**Note:** AL-H and AL-L include AL1H, AL2H and AL1L, AL2L.

**With standby sequence:** It means that the alarm output would be temporarily disabled until when PV value reaches the set value. Then, the alarm output will start to operate.

## ■ Communication Parameters List

Condition of use: Controller must support RS-485 communication function.

- ◆ Supporting transmission speed: 2400, 4800, 9600, 19200, 38400bps
- ◆ Not supporting for the communication format of 7, N, 1 or 8, O, 2 or 8, E, 2
- ◆ Communication protocol: Modbus (ASCII)
- ◆ Available communication address: 1 to 255, 0 is broadcast address
- ◆ Function code: 03H is to read the contents of register (Max. 3 words). 06H is to write 1 (one) word into register.
- ◆ Addresses and contents of data register

Address	Content	Explanation
4700H	Process value (PV)	Measuring unit is 0.1, updated one time in 0.5 second
4701H	Set point (SV)	Unit is 0.1, °C or °F
4702H	Upper-limit alarm 1	
4703H	Lower-limit alarm 1	
4704H	Upper-limit alarm 2	
4705H	Lower-limit alarm 2	
4706H	Upper-limit of temperature range	The data content should not be higher than the temperature range
4707H	Lower-limit of temperature range	The data content should not be lower than the temperature range
4708H	Kp Proportional band	1 to 9999, unit is 0.1
4709H	Ki Integral time	0 to 9999
470AH	Kd Differential time	0 to 9999
470BH	Heating/Cooling hysteresis	0 to 9999
470CH~ 470FH		Reserved
4710H	Input temperature sensor type	Please refer to the contents of the "Temperature Sensor Type and Temperature Range" for detail
4711H	Control method	0: PID (default), 1: ON/OFF, 2: manual tuning
4712H	Heating/Cooling control cycle	1 to 99 second
4713H	Proportional control offset error value	0% to 100%

Address	Content	Explanation
4714H	Temperature regulation error value	-127 to +127
4715H	Alarm 1 type	Please refer to the contents of the "Alarm Outputs" for detail
4716H	Alarm 2 type	Please refer to the contents of the "Alarm Outputs" for detail
4717H	Temperature unit display selection	°C: 1 (default), °F: 0
4718H	Heating/Cooling control Selection	Heating: 0 (default), Cooling: 1
4719H	Control Run/Stop setting	Run: 1 (default), Stop:0
471AH	Communication write in selection	Communication write in disabled: 0 (default) Communication write in enabled: 1
471BH	Software version	V1.00 indicates 0×100

## ■ Communication Protocol

Command code: 03H, read N words. The maximum value of N is 3.

For example, reading continuous two words from starting data address 4700H of controller with communication address 01H.

### ASCII mode:

Command message:

STX	‘.’
ADR 1	‘0’
ADR 0	‘1’
CMD 1	‘0’
CMD 0	‘3’
Starting data address	‘4’
	‘7’
	‘0’
	‘0’
Number of data (count by word)	‘0’
	‘0’
	‘0’
	‘2’
LRC CHK 1	‘B’
LRC CHK 0	‘3’
END 1	CR
END 0	LF

Response message:

STX	‘.’
ADR 1	‘0’
ADR 0	‘1’
CMD 1	‘0’
CMD 0	‘3’
Number of data (count by byte)	‘0’
	‘4’
Content of start address 2102H	‘0’
	‘1’
	‘9’
Content of start address 2103H	‘0’
	‘0’
	‘0’
LRC CHK 1	‘6’
LRC CHK 0	‘7’
END 1	CR
END 0	LF

LRC check:

LRC check is the added sum from "Address" to "Data content". For example, 01H + 03H + 47H + 00H + 00H + 02H = 4DH, then take the complementary of 2, B3H.

Command code: 06H, write 1 (one) word

For example, write 1000(03E8H) into the starting data address 4701H of controller with 01H.

## ASCII mode:

Command message:

STX	‘.’
ADR 1	‘0’
ADR 0	‘1’
CMD 1	‘0’
CMD 0	‘6’
Starting data address	‘4’
	‘7’
	‘0’
	‘1’
Data content	‘0’
	‘3’
	‘E’
	‘8’
LRC CHK 1	‘C’
LRC CHK 0	‘6’
END 1	CR
END 0	LF

Response message:

STX	‘.’
ADR 1	‘0’
ADR 0	‘1’
CMD 1	‘0’
CMD 0	‘6’
Starting data address	‘4’
	‘7’
	‘0’
	‘1’
Data content	‘0’
	‘3’
	‘E’
	‘8’
LRC CHK 1	‘C’
LRC CHK 0	‘6’
END 1	CR
END 0	LF

## ■ External Dimensions (units: mm)

### DTA4848

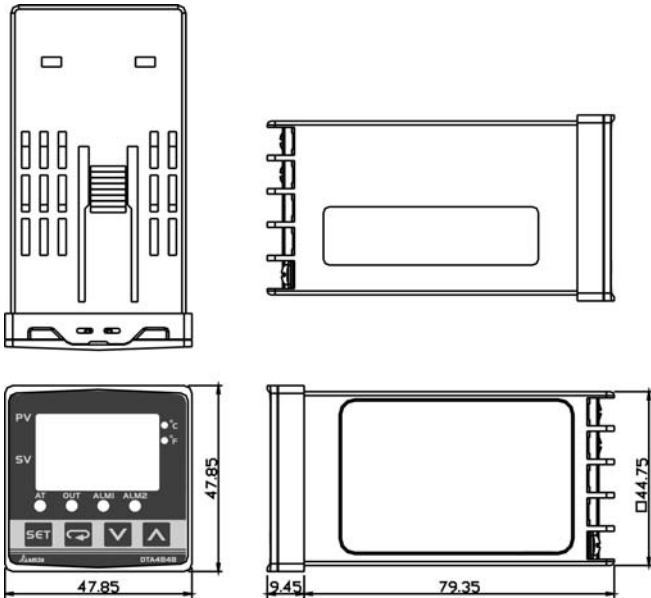

### DTA4896

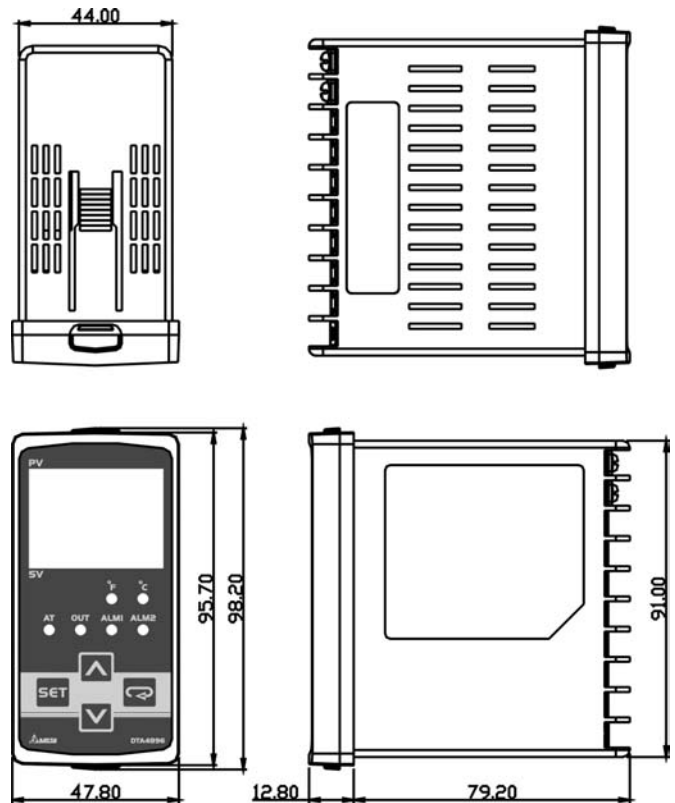

## DTA7272

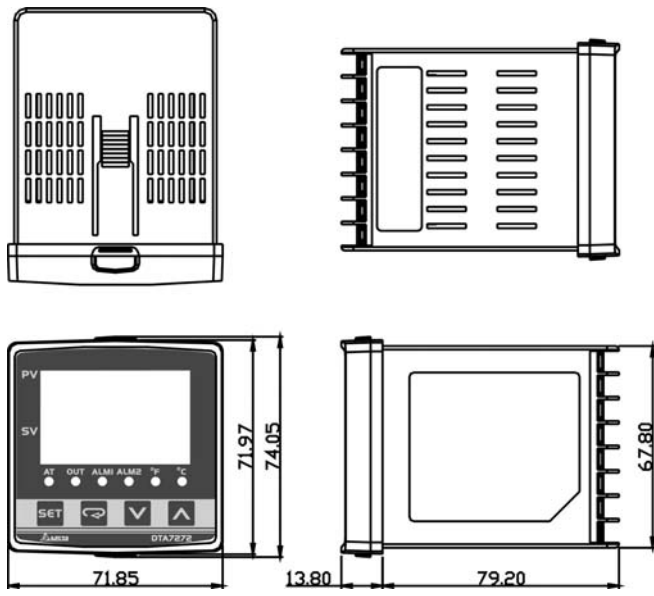

## DTA9696

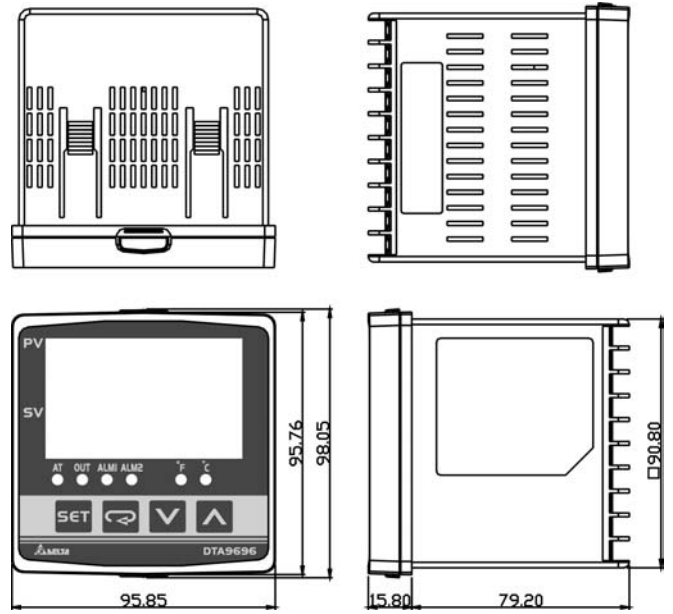

## ■ Terminals Connection

### DTA4848

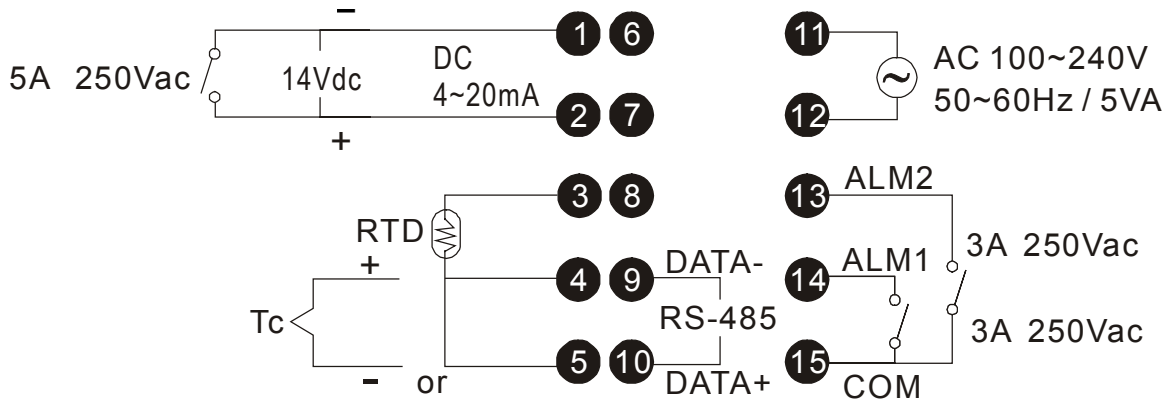

**DTA4896/DTA9696**

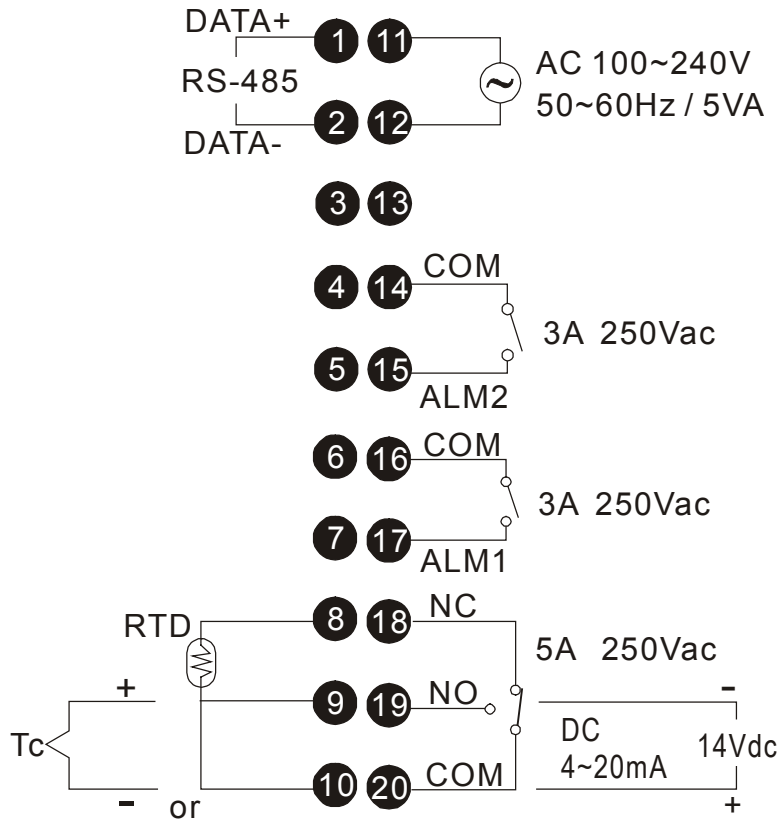

**DTA7272**

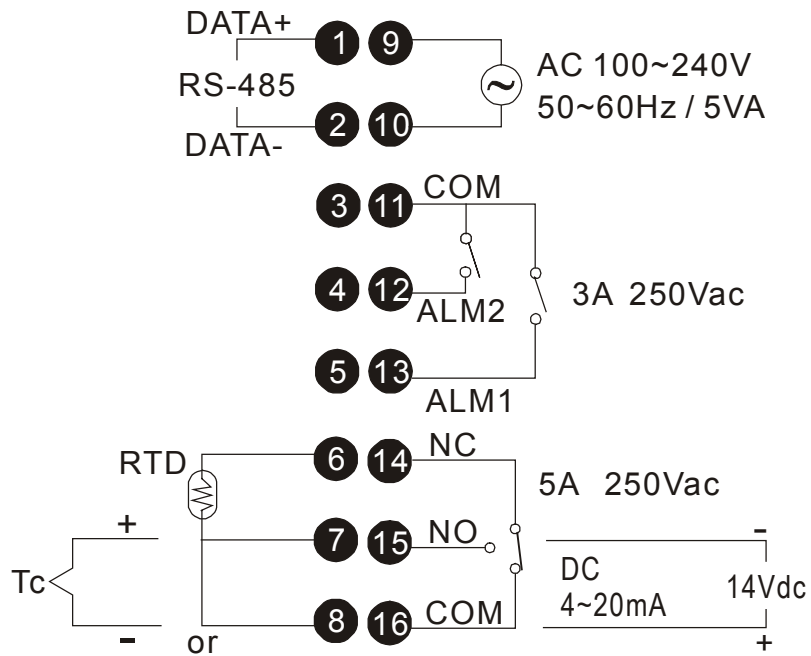

## ■ Panel Cutout (units: mm)

1. 48\*48

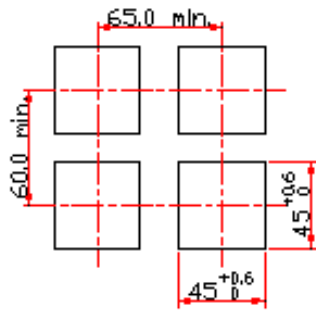

2. 48\*96

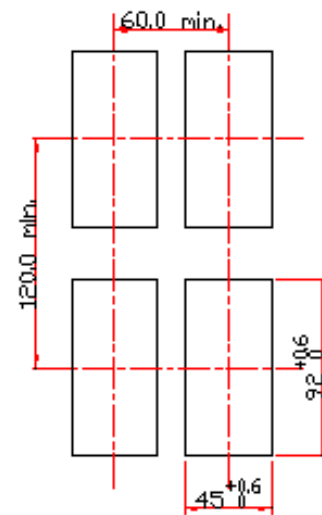

3. 72\*72

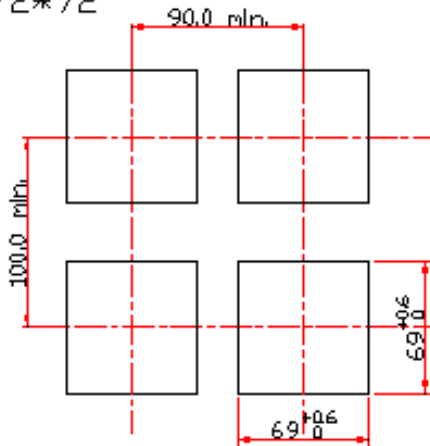

4. 96\*96

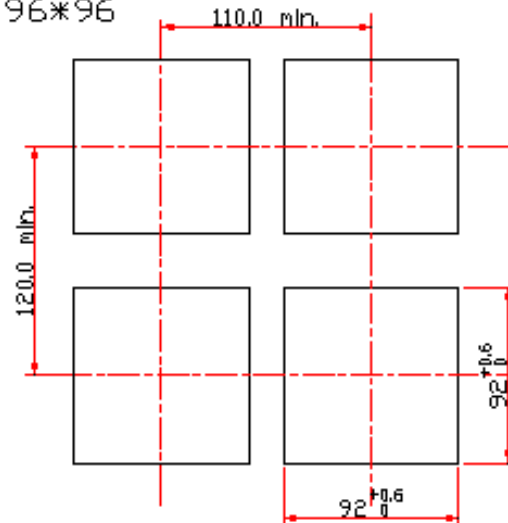

## ■ Mounting

Step-1. Insert the controller through the panel cutout.

Step-2. Insert the mounting bracket into the mounting groove at the top and bottom of the controller and push the mounting bracket forward until the bracket stops at panel wall.

Step-3. Insert and tighten screws on bracket to secure the controller in place.

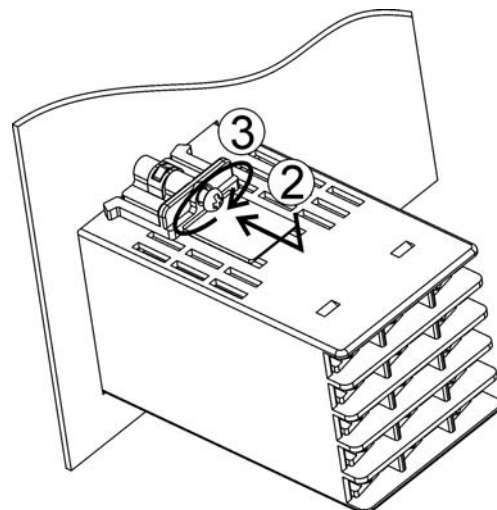
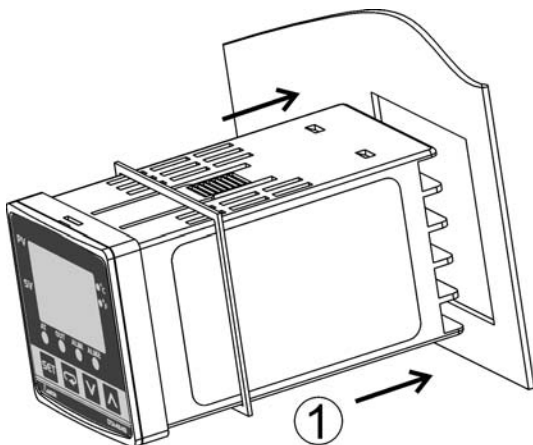

## ■ Mounting Bracket Installation

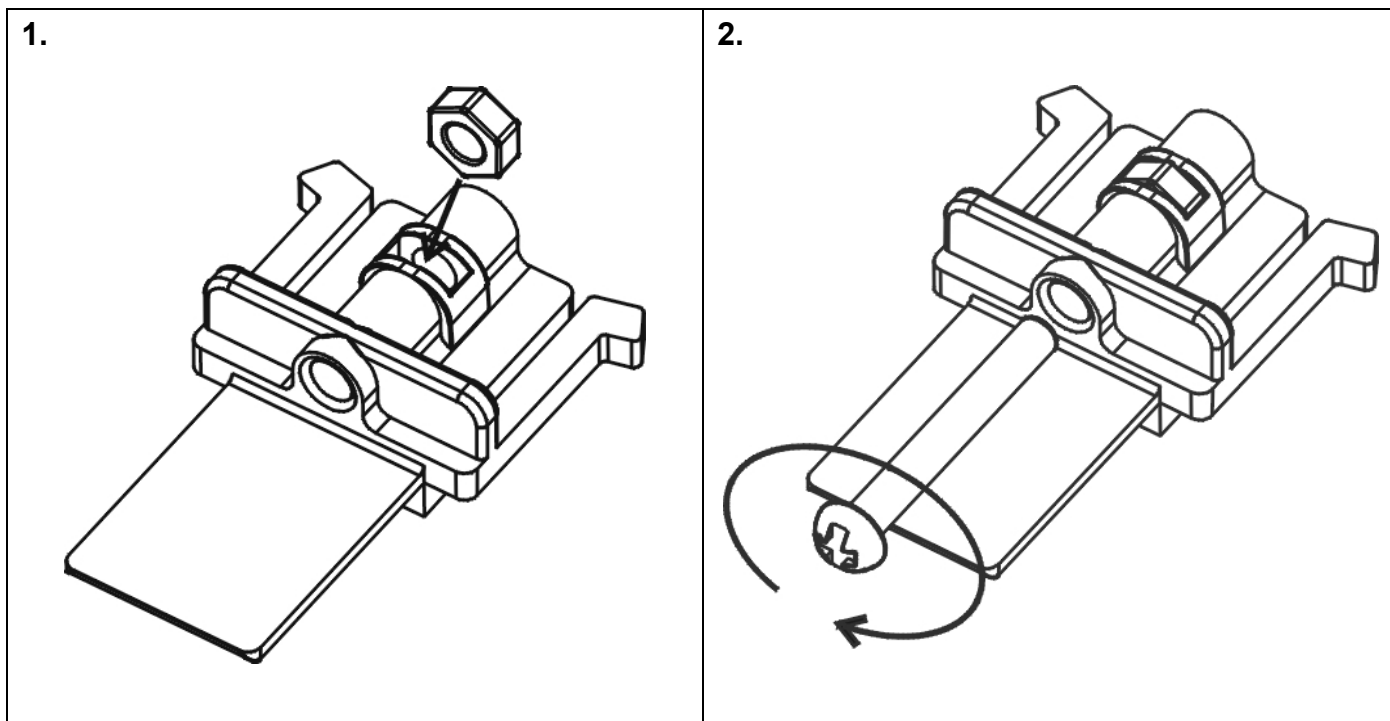

### ASIA

**DELTA ELECTRONICS, INC.**

**TAOYUAN Plant/**

31-1, SHIEN PAN ROAD,

KUEI SAN INDUSTRIAL ZONE

TAOYUAN 333, TAIWAN

TEL: 886-3-362-6301

FAX: 886-3-362-7267

### NORTH/SOUTH AMERICA

**DELTA PRODUCTS  
CORPORATION**

**Sales Office/**

P.O. BOX 12173

5101 DAVIS DRIVE

RTP, NC 27709 U. S. A.

TEL: 1-919-767-3813

FAX: 1-919-767-3969

### EUROPE

**DELTRONICS (Netherlands)  
B.V.**

**Sales Office/**

Industriegebied Venlo Nr. 9031

Columbusweg 20

NL-5928 LC Venlo

The Netherlands

TEL: 31-77-324-1930

FAX: 31-77-324-1931