

Users manual



Ht40AL

User - friendly programmable controller

1 Important

Ht40AL is a temperature / process controller intended for the built-in to panel. The format of controller is 96 x 96 mm (1/4 DIN).

The controller enables simple controlling via program ... 2 x ramp and soak or controlling to stp value. It is equipped with 1 input (thermal or process) and 3 outputs (control, auxiliary and alarm).

The controller is easy to run and operate. The parameters set can be locked and thus preventing from deleting by a user.

User manual for the controller Ht40AL is divided into the particular chapters. When you install and put it into operation we recommend proceeding in the following way:

If you are a final user, the controller is in the default setting by the supplier

If you are a final user, you will get the device in the customized setting and you can view and change only the parameters that you need for your own work on the controller.

If you are a new user of the device, focus on the following chapters:

- Basic terms, here it is explained the key functions, displays, and so on....
- Basic mode, the description of basic mode of controller.
- Controlling of stp value, program, all you need to know when you start programming.

If you are carrying out the complete installation and setting of the controller

In this case you proceed in accordance with the following chapters:

- Installation, in this chapter it is described how to build in a controller into panel.
- Principals of installation, we recommend you to observe the guidelines described in this chapter.
- Wiring, the description for wiring of the controller.
- Putting into operation, at first power-up you enter the initial menu in which you can configure and set the most important parameters of controller.

According to the procedure you will perform installation, wiring and basic setting of controller. You can find out more details on the scope of the controller and its operation in the following chapters.

For the users who have the controller completely set, we recommend to perform the setting of all the parameters in *service level*, menu **CONF**. **Initial password** for the entry to service level is set to **995**.

2 Basic terms

To avoid problems in operation of device the user should be able to manage its operation, setting parameters, ...

2.1 Operation and description of controller





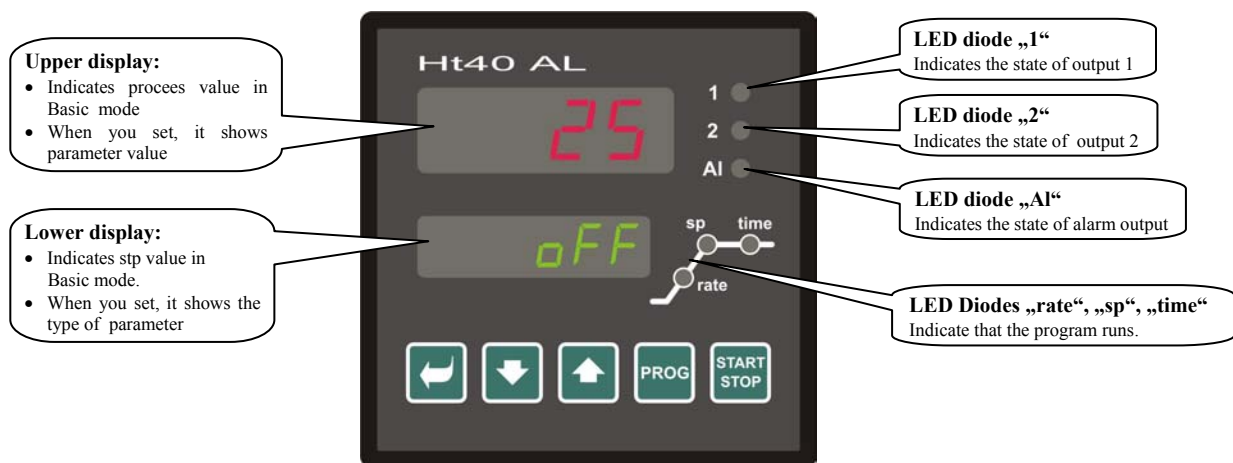

On the front panel board you can see 2 displays, 6 control lights (LED diodes) for indicating a status of outputs and program. The device is set and configured via 5 key-buttons.

Function of indicators



Function of key-buttons

The setting of parameters of the controller is performed via key-board. The function of each key-button is as follows:

-  key for setting and viewing of parameters of user, operation, configuration and user level. By pressing this key **you confirm the change in configured parameter** and the controller comes to another parameter.
-  key for decreasing a value of parameter. The value of parameter is either the figure or abbreviation composed of maximum 4 letters.
-  key for increasing a value of parameter.
-  the key intended for editing and reading a program. When you press this key, the actual parameter of program is written and the controller comes to the following parameter.
-  the key intended for the starting and the ending of a program. By double press of the key you start / end a program.
-   the contemporary pressing of both arrow-keys. Short pressing returns the controller to basic mode, see page 5. Long pressing allows to get to the higher levels of menu (operational, configuration, service).

2.2 Information and error messages

Information and error messages are indicated only in *basic mode*, see page 5.

Information messages, upper display

- ---- ... error of input sensor or input is not set.

Information messages, lower display

- **ProG** ... the indication of the program running.
- **tdEL** ... indication of time-delayed start of program.
- **Gsd** ... GSD function, process value is beyond the defined soak band.
- **Aut1** ... starting autotuning of PID set 1, **Pb1A** , **It1A** , **dE1A** see page 11.
- **Aut2** ... starting autotuning of PID set 2, **Pb1b** , **It1b** , **dE1b** see page 11.

Error messages, lower display

If there is an error message indicated, then the control outputs are switched OFF, the signal output is switched OFF, the alarm output is activated.

- **Err0** ... error in FLASH memory of program. Switch the controller OFF and ON again. If the problem persists, contact your supplier.
- **Err1** ... error in EEPROM memory for configuration and operation parameters. The troubleshooting error can be made by restarting of all parameters in service *level*. After restart it is necessary to set up all parameters again. This can be done only by an experienced user. If the trouble persists, contact your supplier.
- **Err3** ... error in A/D converter. It can be caused by electrical impulse at input, too low temperature and excessive humidity, Switch the controller OFF and ON again. If the problem persists, contact your supplier.

2.3 Overview of levels, menus

For the right function of the controller it is necessary to set up its parameters properly. For better understanding the parameters are sorted out to groups (levels and menus). Level is superior to menu, menu is a part of level (menu **out1**). The structure of sorting shows the following picture.

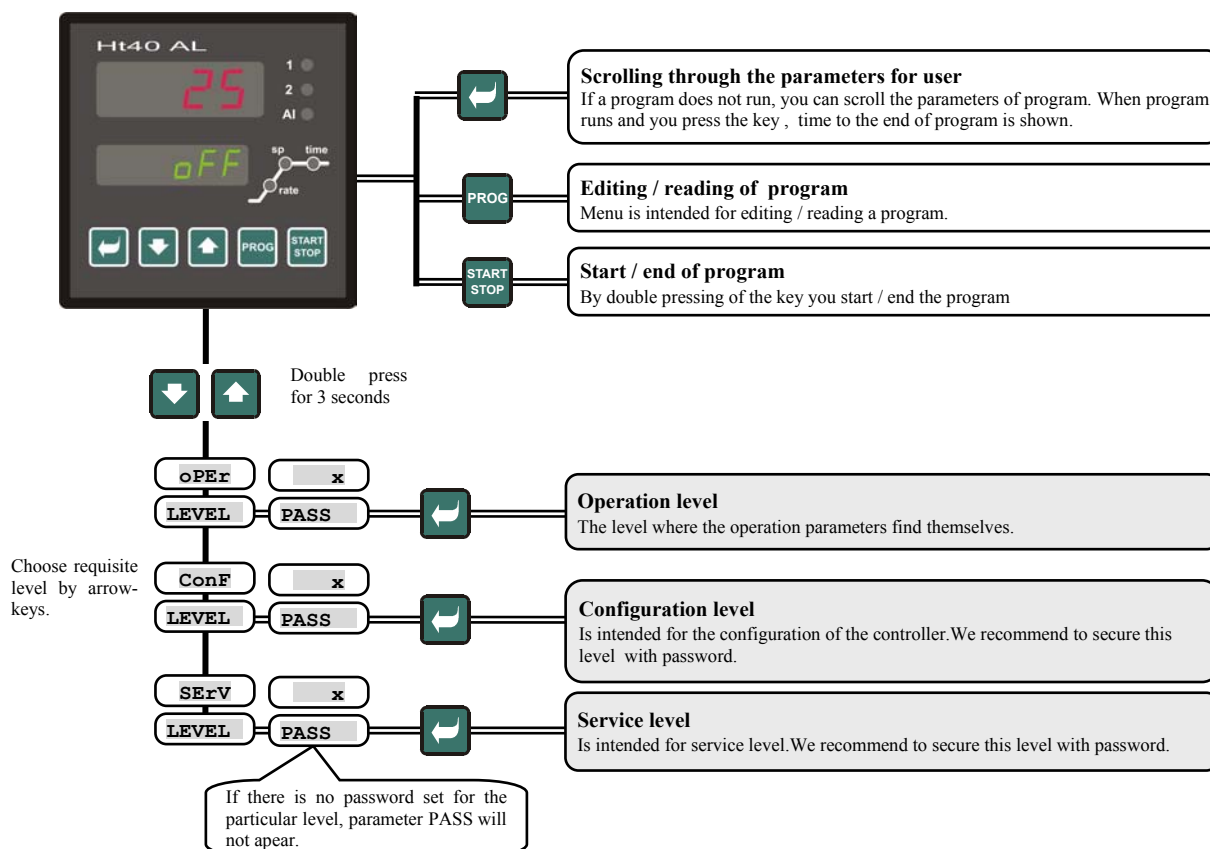

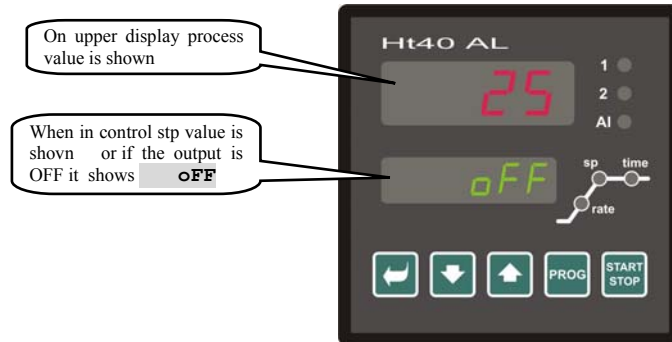

3 Basic mode

The controller is in **Basic mode** when powered up (the initial set-up must be performed, see page [26](#)). On upper display process value is shown, on lower display there can be stp value or heading **OFF**



- If there is a heading **OFF** on lower display, the controller is in **basic mode**, stp value is turned OFF, the control output is switched OFF.
- If there is a figure on lower display, heading **PROG** does not blink, the controller is in **basic mode** and controls to stp value SP1.
- If there is a figure on lower display, heading **PROG** blinks, the controller is in basic mode and runs acc. to the requested program.
- If there is any other heading on lower display, the controller is **not in basic mode**, parameters are set or viewed.
- Information and error messages are indicated only in **basic mode**, see page [4](#)

Return to basic mode

- To return to **basic mode** press shortly the keys  .
- If there is no key pressed for 60 seconds, the controller itself returns to **basic mode**.

4 Controlling of stp value, program

The controller is designed as simply programmable. It enables controlling to stp value or controlling by the simple program (ramp and soak).

4.1 Controlling of stp value

When the controller maintains stp value, lower display shows stp value and upper display shows process value. Setting of stp value can be changed with the arrow-keys, the new stp value is edited after approx. 2 seconds since the last pressing of the key.



Setting of controlling to stp value

Carry out the setting in *configuration level*, menu **sys** , parameter **SLEEP** = **SP1**. After return to basic mode stp value is shown on lower display.

4.2 Controlling by simple program

In the controller you can set the program with 1 or 2 ramp functions. Setting is done in *configuration level*, menu **SYS**, parameter **SP1C**:

- **SP1C** = **PG1** ... is set the program with 1 ramp function.
- **SP1C** = **PG2** ... is set the program with 2 ramp functions.

Program with 1 ramp function

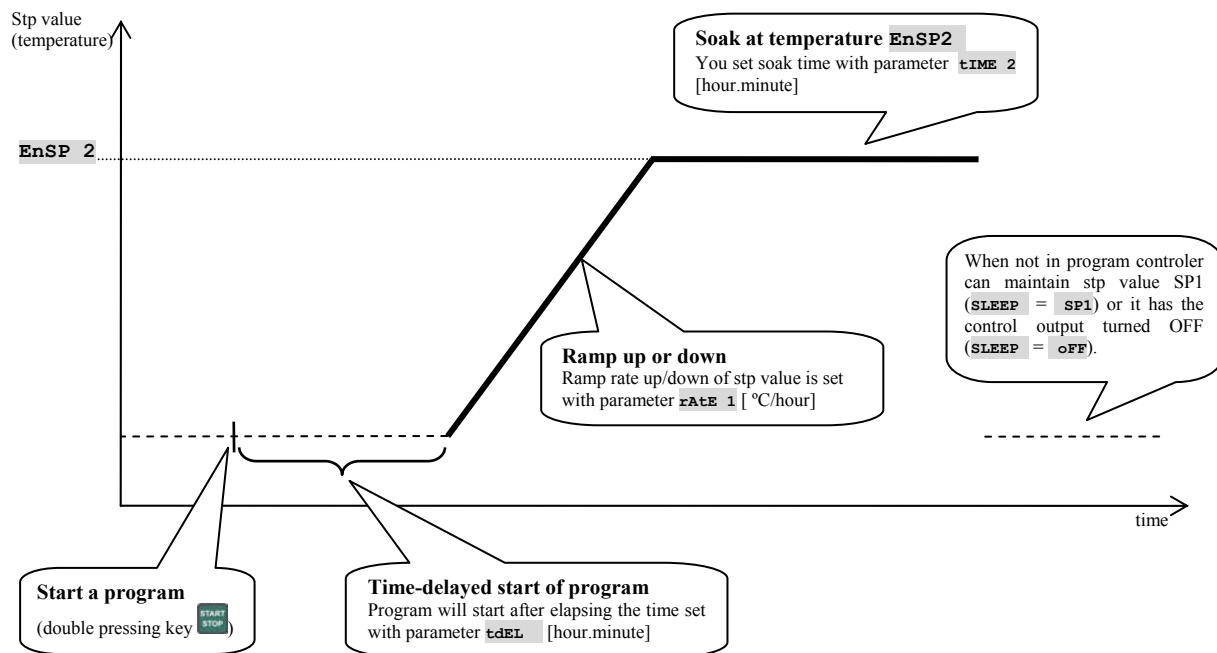

Setting of program parameters

By the key **PROG** you scroll the parameters for setting a program. The following table shows the overview of all the parameters.

Display	Meaning
tdEL	Time-delayed start of program [hour.minute] If you set OFF , program starts at once. Range: OFF , 0.01 to 23.59 [hour.minute]. Parameter is shown and time-delayed starts allowed, if in <i>configuration level</i> , menu SYS , parameter is set to tdEL = on .
rAtE 1	Rate up/down to stp value [°C/hour] If you set OFF , the function of rate up/down to stp value is omitted, soak at temperature EnSP2 starts. Range: OFF , 1 to 999 [°C/hour].
EnSP 2	Stp value for soak Range: r Lo1 to r hI1 .
tIME 2	Soak [hour.minute] If you set OFF , soak is turned OFF. Range: OFF , 0.01 to 99.59 [hour.minute].

Program with 2 ramp functions

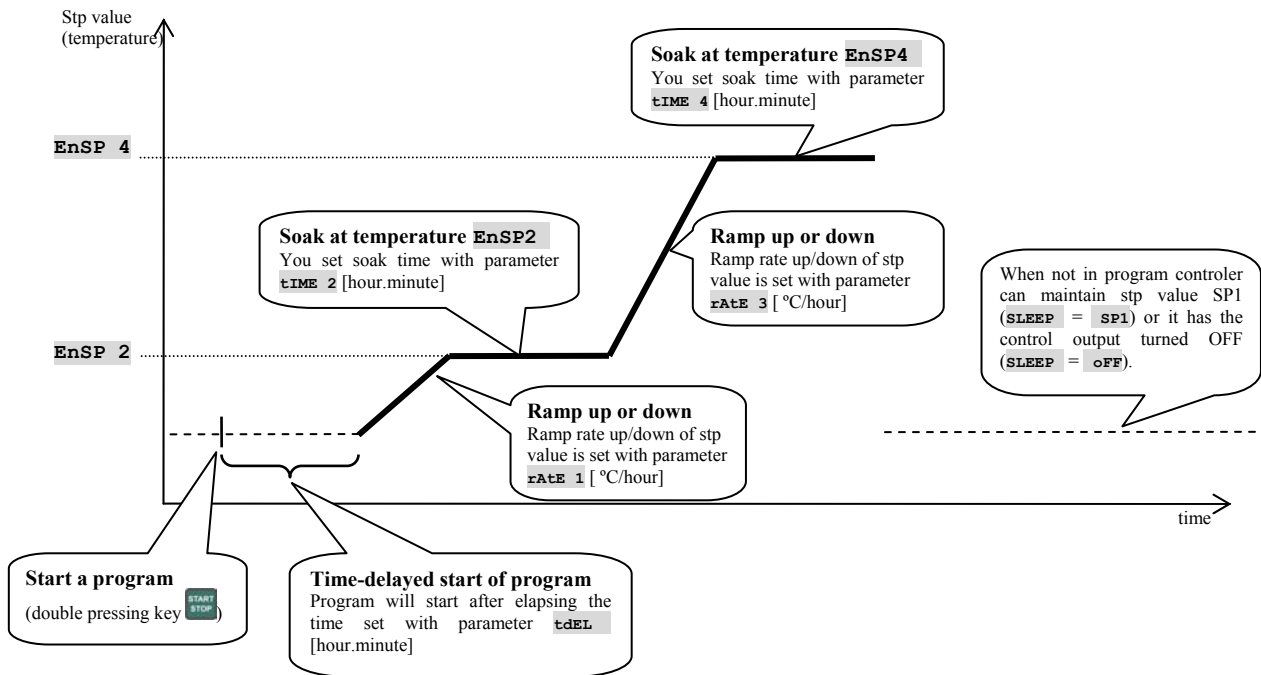



Setting of program parameters

By the key **PROG** you scroll the parameters for setting a program. The following table shows the overview of all the parameters.

Display	Meaning
tDEL	Time-delayed start of program [hour.minute] If you set OFF , program starts at once. Range: OFF , 0.01 to 23.59 [hour.minute]. Parameter is shown and time-delayed starts allowed, if in <i>configuration level</i> , menu SYS , parameter is set to tDEL = on .
rAtE 1	Rate up/down to stp value [°C/hour] If you set OFF , the function of rate up/down to stp value is omitted, soak at temperature EnSP2 starts. Range: OFF , 1 to 999 [°C/hour].
EnSP 2	Stp value for soak Range: r Lo1 to r hI1 .
tIME 2	Soak [hour.minute] If you set OFF , soak is turned OFF. Range: OFF , 0.01 to 99.59 [hour.minute].
rAtE 3	Rate up/down to stp value [°C/hour] If you set OFF , the function of rate up/down to stp value is omitted, soak at temperature EnSP4 starts. Range: OFF , 1 až 999 [°C/hour].
EnSP 4	Stp value for soak Range: r Lo1 to r hI1 .
tIME 4	Rate up/down to stp value [°C/hour] If you set OFF , the function of rate up/down to stp value is omitted, soak at temperature EnSP4 starts. Range: OFF , 1 to 999 [°C/hour].

Starting, ending a program

If a program does not run, you can start it by double pressing . The program will end up after elapsing the requested time. If you interrupt the program before it ends itself, press twice the key  again.

Time-delayed start of the program (parameter `tDEL`) you can set it in configuration level, menu `sys`, parameter `tDEL` = `on`.

The time-delayed start is indicated with blinking heading `tDEL` on lower display. When you press the key  time remaining to the start of program is shown.

Running a program

The run of program is indicated with blinking heading `PROG` on lower display.

The chosen duration of soak is ensured with the function „GSD“ (guaranteed soak deviation). At the beginning of the soak the controller waits for the process value to get into the soak band `GS dE` within a window around `stp` value, only the counting down starts:

- You can set the soak band in *configuration level*, menu `sys`, parameter `GS dE`.
- If parameter `GS dE` = `OFF`, the function „GSD“ is turned OFF.
- If the process value is beyond the set soak band with the parameter `GS dE`, time is paused and heading `Gsd` blinks on lower display.

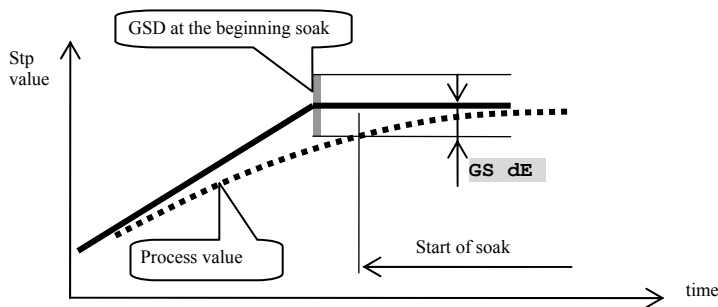

When in program after the pressing the key  it shows the time till the end of the program, parameter `trEM`. This particular is only informative. The real time can be influenced by the function „GSD“.





When the program runs, you can change the setting of the program, the change is immediately carried out.

The enter to the setting of program can be secured with password. The password is set in *configuration level*, menu `PASS`, parameter `PAS Pr`.

When in program, you can not enter configuration neither service level.

5 Operation level

In operation level you can set parameters which are available to a user.

From basic mode to operation level you will get by pressing the keys   for 3 seconds. On lower display it appears **LEVEL**, on upper display set **oPEr** and confirm with the key . If **PASS** appears on lower display the level is secured with the password. In this case set the right password with the arrow-keys and confirm with the .

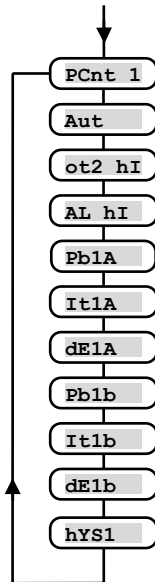

Menu of operation level

Display	Meaning
PCnt 1	Shows the actual power of the output 1 in %.
Aut	Starting / turning OFF of autotuning of PID parameters: <ul style="list-style-type: none"> oFF, turning OFF of autotuning of PID parameters. ht, starting of autotuning of PID parameters, heating.
ot2 hI	High limit of signalling. Signal output is activated when measured value is <i>higher</i> than the set limit. Range: 1 to 2499 °C.
AL hI	High limit of alarm. Alarm is activated, if process value is <i>higher</i> than the set limit. Range: - 499 to 2499 °C.
Pb1A	Proportional band of the output 1, the first set of PID parameters. Range: 1 to 2499 °C.
It1A	Integral value of the output 1, the first set of PID parameters. Range: oFF, 0.1 to 99.9 minutes.
dE1A	Derivative value of the output 1, the first set of PID parameters. Range: oFF, 0.01 to 9.99 minutes.
Pb1b	Proportional band, the second set of PID parameters. Range: 1 to 2499 °C.
It1b	Integral value, the second set of PID parameters. Range: oFF, 0.1 to 99.9 minutes.
dE1b	Derivative value, the second set of PID parameters. Range: oFF, 0.01 to 9.99 minutes.
hYS1	Hysteresis of the output 1, this single parameter is set only for ON/OFF control. Range: 1 to 249 °C.

5.1 Parameters of the control output, PID controlling

Parameters **Pb1A** , **It1A** , **dE1A** , **Pb1b** , **It1b** , **dE1b** , define the behavior of the controller. They can be set from the keyboard or with the controller, with starting autotuning (the function **Aut**).

The controller can use 1 PID set (**Pb1A** , **It1A** , **dE1A**) or both PID sets (**Pb1A** , **It1A** , **dE1A** , **Pb1b** , **It1b** , **dE1b**).

The complete description of setting for the control output is on page [16](#).

Autotuning

The controller is fitted with the function that sets automatically PID parameters.

You can start autotuning in a program as well as in controlling to stp value, but the control output must not be turned OFF.

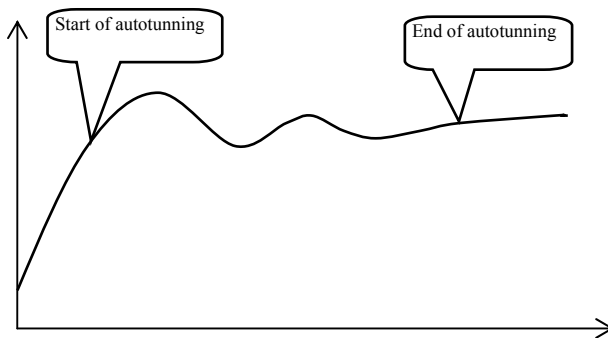

Procedure of starting autotuning:

- The controller must switch the output ON/OFF, it means that the control output must not be turned (in *basic mode* on lower display there must not be **oFF**).
- Autotuning you can start with parameter **Aut** = **ht** (setting parameters for heating). Parameter **Aut** you will find in *operation level*. The control output must be set for PID controlling.
- The controller explores the characteristics of system from switching ON/OFF on the output and determines optimal PID parameters. It can cause an overshoot.
- On lower display the information message **Aut1** blinks (setting parameters for heating **Pb1A** , **It1A** , **dE1A**), **Aut2** blinks (setting parameters for heating **Pb1b** , **It1b** , **dE1b**).

Important:

- Parameters **Pb1A** , **It1A** , **dE1A** , are set when 1 set of PID parameters is used (**ALGo** = **PId**) or the both sets of PID parameters are used (**ALGo** = **2PId**) and the actual set point value is lower than parameter **SWPId**.
- Parameters **Pb1b** , **It1b** , **dE1b** , are set if the actual set point value is higher than parameter **SWPId** when the both sets of PID parameters are used (**ALGo** = **2PId**)

Parameters **ALGo** and **SWPId** are found in *configuration level*, menu **out1** .

5.2 Alarm output

Alarm output is intended for the indication that process values exceeded the limit temperature set with the parameter **AL hI** .

This parameter is found in *operation level*.

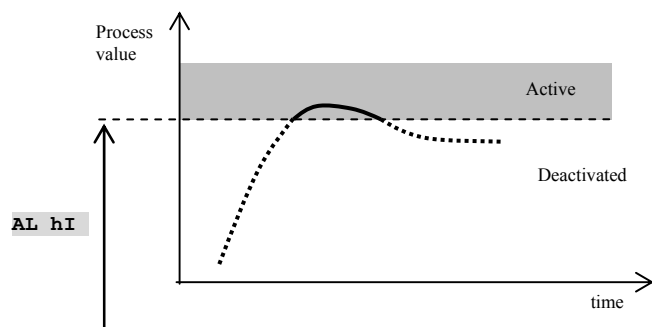

If alarm is not active, relay is **switched ON**, if alarm is active, relay is **switched OFF**.

Alarm is also activated when a sensor is broken and if there is a system error of controller.



6 Configuration level

Configuration level is intended for the basic setting of the controller. In this level **the control output is turned OFF and alarm and signal outputs are deactivated.**

To enter configuration level from basic mode press both the keys   for 3 seconds. On lower display it appears **LEVEL**, on upper display set via the arrow-keys **ConF** and confirm. If **PASS** appears on lower display, configuration level is secured with the password. In this case set the password via the arrow-keys and confirm again .

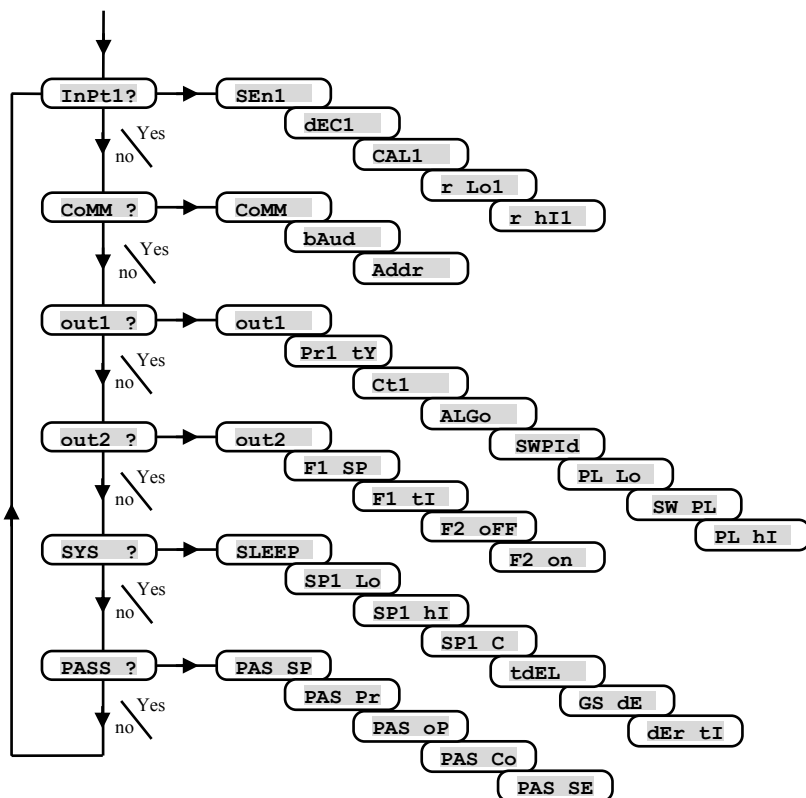

InPt1 , input setting

Display	Meaning
	Setting of input sensor – thermal input.
	<ul style="list-style-type: none"> no ... input is not set. J ... thermocouple J, range -200 to 900°C. K ... thermocouple K, range -200 to 1360°C. t ... thermocouple T, range -200 to 400°C. n ... thermocouple N, range -200 to 1300°C. E ... thermocouple E, range -200 to 700°C. r ... thermocouple R, range 0 to 1760°C. S ... thermocouple S, range 0 to 1760°C. b ... thermocouple B, range 300 to 1820°C. C ... thermocouple C, range 0 to 2320°C. d ... thermocouple D, range 0 to 2320°C. rtd ... rtd sensor (Pt100), range -200 to 800°C.
	Setting of input sensor ... process input:
SEn1	<ul style="list-style-type: none"> no ... input is not set. 0-20 ... 0 – 20 mA, range -499 to 2499 units. 4-20 ... 4 – 20 mA, range -499 to 2499 units. 0-5 ... 0 – 5 V, range -499 to 2499 units. 1-5 ... 1 – 5 V, range -499 to 2499 units. 0-10 ... 0 – 10 V, range -499 to 2499 units.

Display	Meaning
dEC1	Setting of decimal point for displaying – thermal input. <ul style="list-style-type: none"> 0 ... no decimal point. 0.0 ... 1 decimal point. Setting of decimal point for displaying – process input: <ul style="list-style-type: none"> 0 ... no decimal point. 0.0 ... 1 decimal point. 0.00 ... 2 decimal points. 0.000 ... 3 decimal points
CAL1	Correction of sensor. The set value is added to process value. Range: -999 to 999 °C.
r Lo1	Together with parameter r hI1 you also set the scale of displaying measured values for process input ranges. Range: -499 to r hI1 .
r hI1	Together with parameter r Lo1 you also set the scale of displaying measured values for process input ranges. Range: r Lo1 to 2499.

CoMM , communication line

Display	Meaning
CoMM	Setting of communication line: <ul style="list-style-type: none"> Mod ... the controller is set for communication with PC. SgnL ... the controller transmits information for controlling of SLAVE units.
bAud	Baudrate of communication, is in default setting - 9600Bd.
Addr	Address of the equipment, it is shown when CoMM = Mod.

out1 , output 1

Display	Meaning
out1	Function of the control output 1: <ul style="list-style-type: none"> ht ... the heating control, PID controlling. ht2 ... the heating control, ON/OFF controlling.
Pr1 tY	Setting of 1. process output, voltage output: <ul style="list-style-type: none"> 0-10 ... 0 až 10V. 0-5 ... 0 až 5V. Setting of 1. process output, current output: <ul style="list-style-type: none"> 0-20 ... 0 až 20mA. 4-20 ... 4 až 20mA.
Ct1	Time cycle for switching of the output 1. Range: 1 to 200 seconds
ALGo	Algorithms of PID controlling: <ul style="list-style-type: none"> PId ... one set of PID parameters is used. 2PId ... both sets of PID parameters are used.
SWPId	Limit between PID set 1 and PID set 2. Range: -499 to 2499 °C.
PL Lo	Power limit function for the limiting of output power at low measured values, in %. Range: 0 to 100 %.
SW PL	Setting of limit between low and high values of power limit function. Range: -499 to 2499 °C.
PL hI	Power limit function for the limiting of output power at high measured values, in %. Range: 0 to 100 %.

out2 , output 2

Display	Meaning
out2	Function of the output 2: <ul style="list-style-type: none"> oFF ... output 2 is turned OFF. SGPr ... signalling of exceeding measured value. You set the limit of signalling in <i>operation level</i>, parameter ot2 hI ProG ... signalling if the program runs. PEnd ... signalling if the program has been finished, the duration of signalling is 10 seconds. F1 ... user function F1 F2 ... user function F2
F1 SP	Setting of the temperature of the function F1. Range: -499 až 2499 °C.

F1 tI	Setting of the time of the function F1. Range: 1 až 99 minut.
F2 OFF	Setting of the temperature for turning OFF of the second output of the function F2. It is active when the program runs. Range: -499 až 2499 °C.
F2 on	Setting of the temperature for turning ON of the second output of the function F2. It is active when the program does not run. Range: -499 až 2499 °C.

SYS , **system parameters**

Display	Meaning
SLEEP	Function of the key „F“: <ul style="list-style-type: none"> OFF ... the key „F“ has no function. SP1 ... the key „F“ is intended for switching between automatic and manual operation.
SP1 Lo	The limit of low range for stp value. Range: -499 to SP1 hI °C.
SP1 hI	The limit of high range for stp value. Range: SP1 Lo to 2499 °C.
SP1 C	Setting of the program type: <ul style="list-style-type: none"> PG1 ... is set the program with 1 ramp function. PG2 ... is set the program with 2 ramp function .
tdEL	Time-delayed start of program: <ul style="list-style-type: none"> OFF ... time-delayed start is inhibited. on ... time-delayed start is allowed.
Gs dE	Setting of soak band around stp value when a program runs. Range: OFF , 1 to 999 °C. If it is set Gs dE = OFF the function GSD is turned OFF.
dEr tI	It makes the character of derivative value more accurate. The more value is set, the more derivative value is damped down. Range: 1.0 to 100.0 seconds.

PASS , **passwords for the entry to higher levels of menu**

Display	Meaning
PAS SP	Locking of the change of set point value SP1: <ul style="list-style-type: none"> OFF ... set point value SP1 is not locked, you can change it. on ... set point value SP1 is locked.
PAS Pr	The password for entering the menu for editing a program. If it is set OFF , the entry is not secured with password. Range: OFF , 1 to 9999.
PAS oP	Password for the entry to operation level. If it is set OFF , the entry is not secured with password. Range: OFF , 1 to 9999.
PAS Co	Password for the entry to configuration level. If it is set OFF , the entry is not secured with password. Range: OFF , 1 to 9999.
PAS SE	Password for the entry to service level. If it is set OFF , the entry is not secured with password. Range: OFF , 1 to 9999.

6.1 Measurement

The right selection, the installation, the wiring, the location of sensor in the equipment and the corresponding setting of parameters of the controller has the essential importance for the correct function. Parameters for the configuration of the measurement input are in *configuration level*, menu **InPt1**.

Setting of input sensor

Set the corresponding input sensor in parameter **SEn1**. You will find the survey of input sensors in the chapter **Technical parameters**, see page [27](#).

You can set the position of decimal point by parameter **dEC1**. For thermal sensors it is possible to display without decimal point or with 1 decimal point.

Set the calibration of sensor with the parameter **CAL1**. The set value is added to process/measured value.

You can set the limit for set point value in *configuration level*, menu **SYS**, parameters **SP1 Lo** and **SP1 hI**.

Important:

- Thermocouple and RTD inputs have the detection of improperly wired sensor. When the sensor is open or broken, the control output is turned OFF, the alarm output is activated.

Measuring range of process inputs

In *configuration level*, menu **InPt1**, you can define the measuring range of the process inputs with parameters **r Lo1**, **r hI1** and **dEC1**.

Example of setting process input:

You want the input signal 4 to 20 mA to be displayed in the range 6.0 to 24.0.

Set **dEC1** = 0.0, **r Lo1** = 6.0 a **r hI1** = 24.0. The distribution between the values 6.0 and 24.0 will be linear.

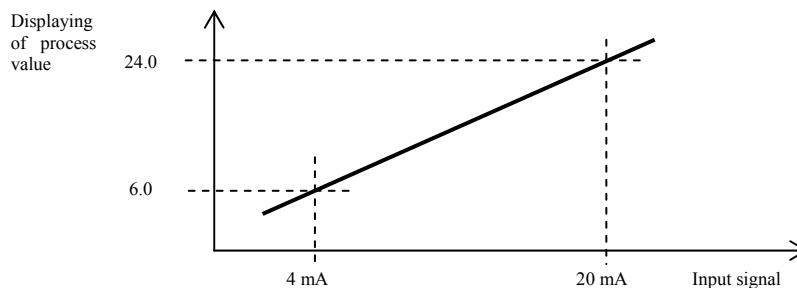

6.2 Controlling, the control output

You can select in the controller ON/OFF or PID controlling for heating. If PID controlling is set, you can use the autotuning of PID parameters, see page [11](#) and the power limit function, see page [17](#).

The parameters for configuration of the control output 1 are in *configuration level*, menu **out1**.

ON/OFF controlling

ON/OFF control is selected by setting **out1** = **ht2**. It is used for less exacting application. It is not possible to achieve zero hysteresis value on principle. The process value rises and drops about set point value in the characteristic way.

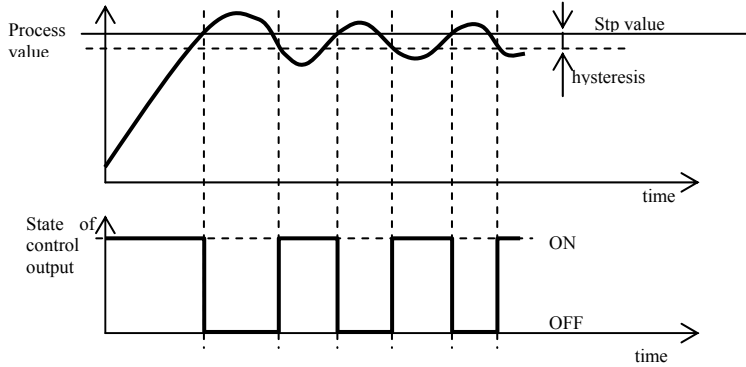

PID controlling

PID control is selected by setting **out1** = **ht**. It provides the precise control. For the correct function of the controller, however, it is necessary to set properly PID parameters. Autotuning for setting of PID parameters is described on page [11](#). PID parameters have the following meaning:

- **pb proportional band** is set in measured units. It is the band about the set point value in which the controller keeps the temperature.
- **it integral factor**, in minutes. Integral factor compensates the loss of system. A **low** integral value causes a **fast** integrating action.
- **ad derivative factor**, in minutes. Derivative responds to fast changes and tries to react against them. The **more** value is, the **more** derivative factor reacts.

If the control output is 2 state (ON/OFF) (relay or SSR), the power is (given in %) transferred to the output with so called pulse width modulation. In each time cycle (parameter **ct1**, you will find it in *configuration level*, menu **out1**) the control output is switched ON once and once OFF. The more the power is necessary, the wider the width of switching is. The output responses are illustrated in the third part of the drawing.

Example of pulse width modulation of the output:

- Time cycle is 10 seconds, the power requested is 30%. The output is ON for 3 seconds and OFF for 7 seconds.
- Time cycle is 10 seconds, the power requested is 5%. The output is ON for 0,5 second and OFF for 9,5 seconds.

Important:

- The duration of time cycle has the influence on the quality of control. The longer the cycle is, the less the quality of control is.
- If the electromechanical unit (relay, switching contactor) is used for the control out
- (Temperature)
- on of time cycle must be set longer with regard to lifetime of switch.

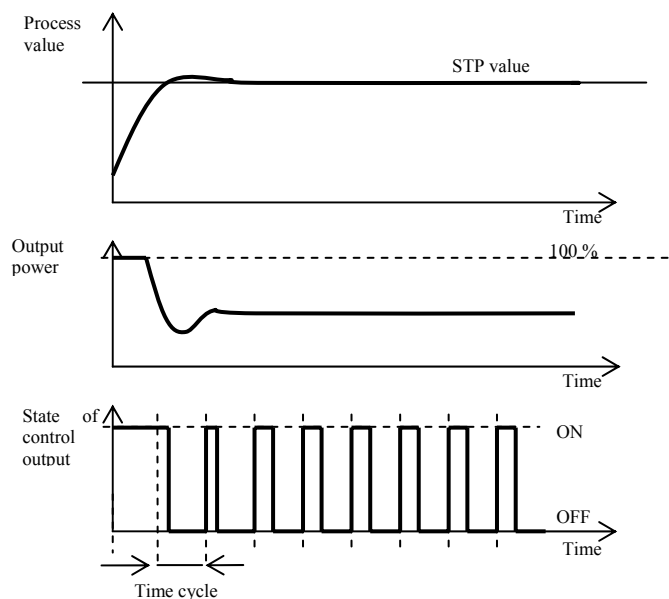

Power limit function

You can improve the quality of control by limiting of the output power.

Examples how to use the power limit function:

When rising at set point value the big overshoot occurs. One of possible solution is the power limit in the vicinity of set point value. The procedure is the following:

- Find out the power supplied to the stable system.
- Set the switcher **S PL** on the value by several °C less than set point value.
- Set power limit **PL Lo** to 100%.
- Set power limit **PL hI** approx. by 10 to 20% higher than the power supplied to the stable system.

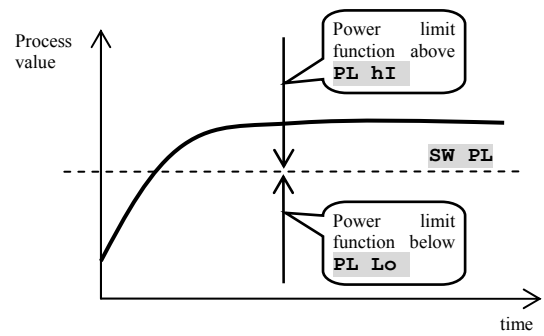

6.3 Function of the output 2

The second output can be set to 1 of the following functions:

- **out2** = **SGPr** ... signalling of exceeding the measured value, absolute value. Limit of signalling is set in operational level, parameter **ot2 hI**.
- **out2** = **ProG** ... signalling that the program runs. The output is switched ON when program runs.
- **out2** = **PEnd** ... signalling that program has ended up. The output is switched ON after the end of a program, the time when the the contact is switched ON is 10 seconds.
- **out2** = **F1** ... users function F1, it is described below.
- **out2** = **F2** ... users function F2, it is described below.

Function F1

Function can be used for example for controlling the fan of the oven/furnace.

The output is switched ON when at least one of the following conditions is fulfilled:

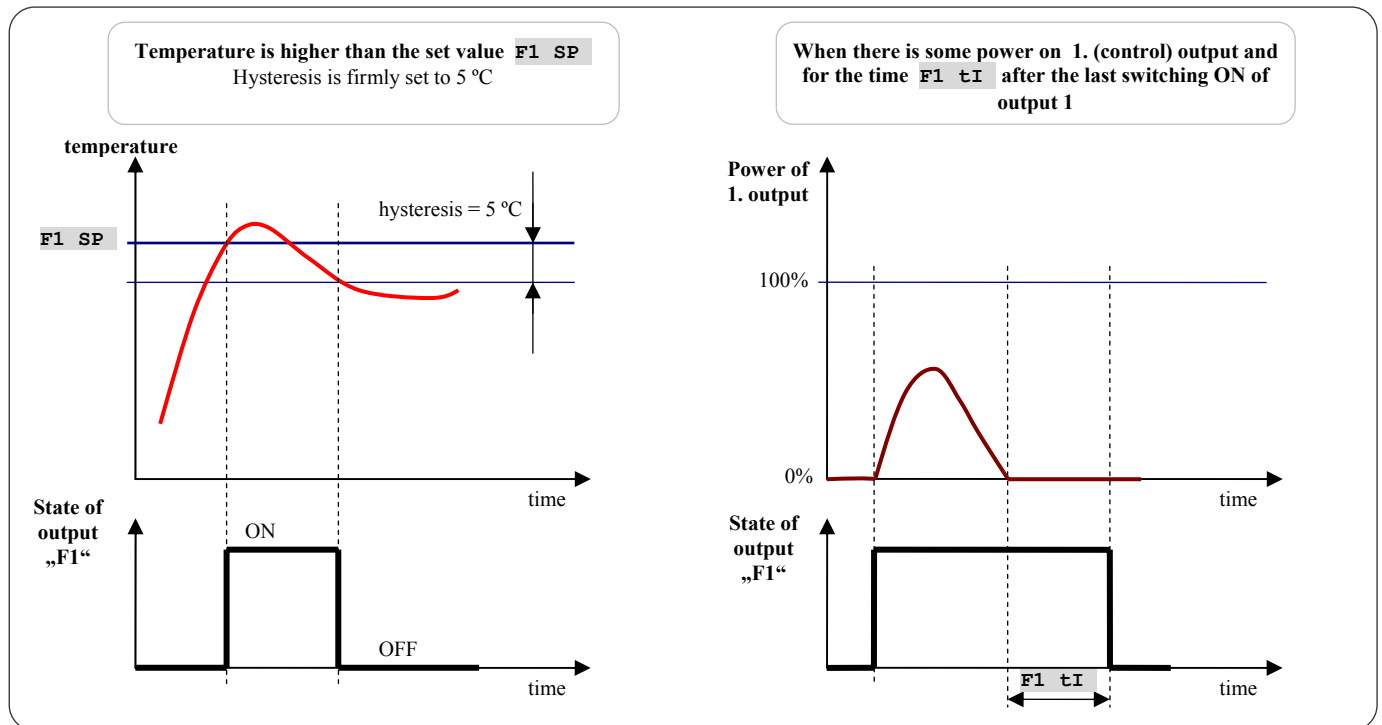

Function F2

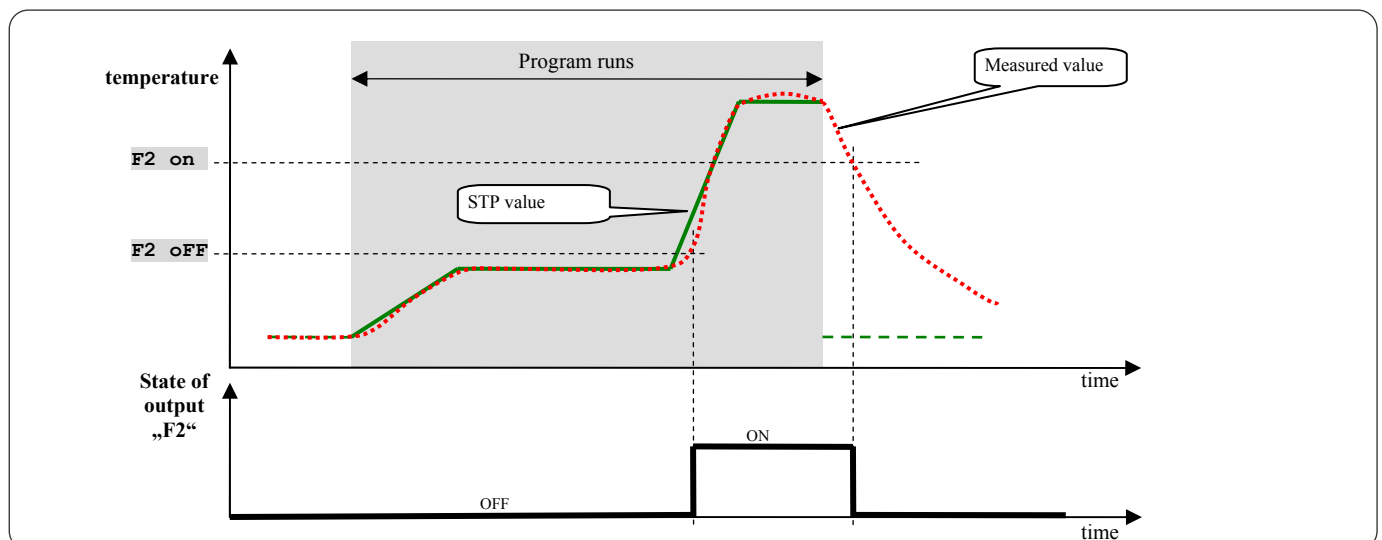

Function can be used for example for the control of ventilation damper of ceramic furnace.

- When program runs, the output 2 is switched ON depending on the set value **F2 OFF**.
- When the program does not run, the output 2 is switched ON depending on the set value **F2 on**.



7 Service level

Service level is intended for service workers. In this level **the control output is switched OFF and alarm and signal output is deactivated.**

To get from basic mode to service level press the keys   for about 3 seconds. On lower display **LEVEL** appears, on upper one set **SErV** and confirms. If **PASS** appears on lower display, level is secured with password. In this case set the correct password with arrow-keys and confirm again.

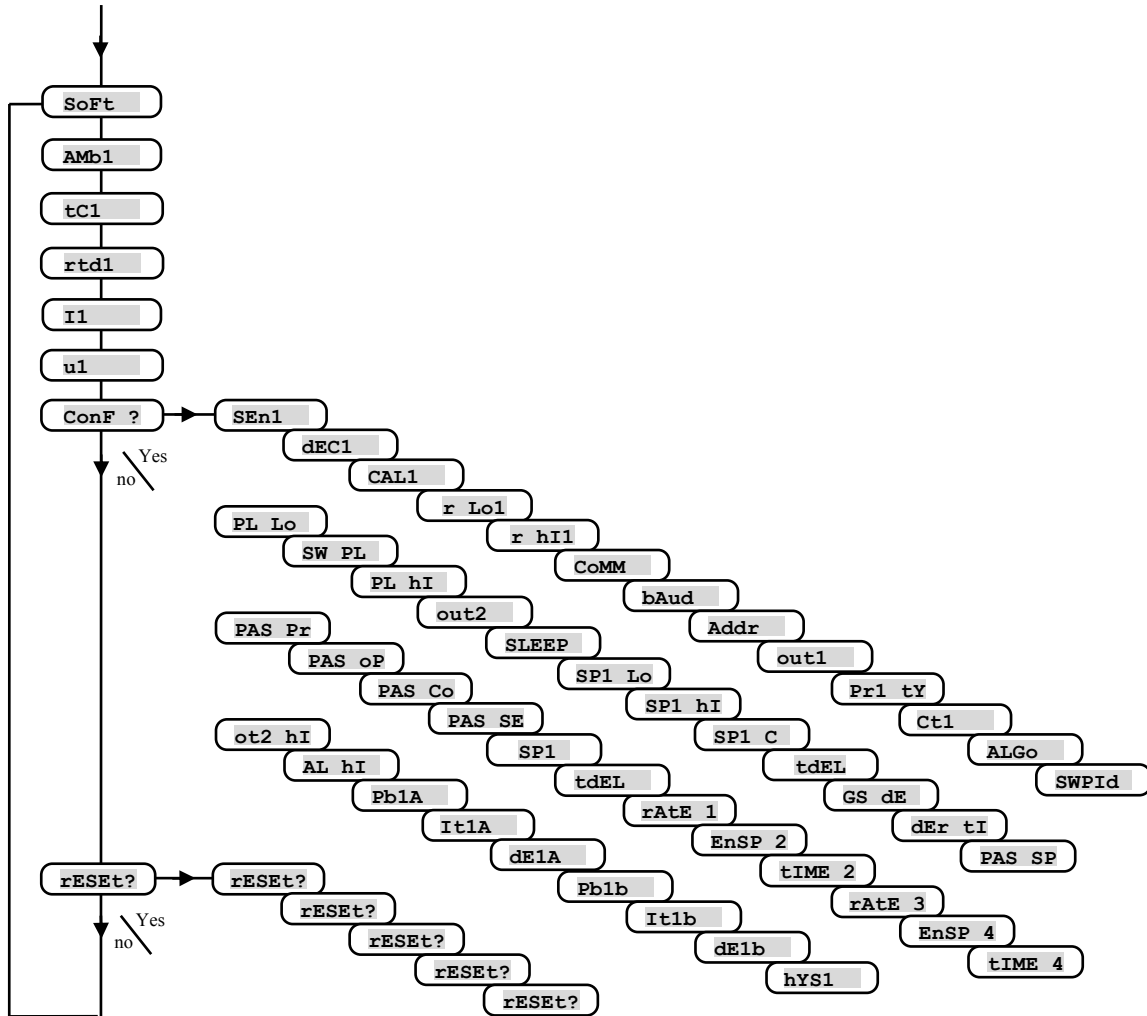

Display	Meaning
SoFt	Number of software version.
AMb1	Actual ambient temperature.
tC1	Measured voltage, thermocouple input 1. Range 60mV.
rtd1	Measured resistance, rtd input 1. Range 350 ohms.
I1	Measured current, current input 1. Range 20mA.
u1	Measured voltage, voltage 1. Range 10V.
ConF ?	By setting YES and confirming you enter the menu for setting all the parameters. This menu can be used e. g. in initial setting of the controller.
rESEt?	Editing of initial parameters is the significant action to controller's setting. First it must be confirmed by 6x setting YES.
rESEt?	
rESEt?	
rESEt?	
rESEt?	
rESEt?	

8 Table of parameters

Table of parameters for configuration level:

SEn1		out2	
dEC1		F1 SP	
CAL1		F1 tI	
r Lo1		F2 oFF	
r hI1		F2 on	
CoMM		SLEEP	
bAud		SP1 Lo	
Addr		SP1 hI	
out1		SP1 C	
Pr1 tY		tdEL	
Ct1		GS dE	
ALGo		dEr tI	
SWPId		PAS SP	
PL Lo		PAS Pr	
SW PL		PAS oP	
PL hI		PAS Co	
		PAS SE	

Table of parameters for operation level:

ot2 hI	
AL hI	
Pb1A	
It1A	
dE1A	
Pb1b	
It1b	
dE1b	
hYS1	

9 Installation

The controller is designed to be mounted to the panel cutout. Slide the controller into the cutout and fix it with 2 flanges that are supplied with the controller. The installation requires the access to the back of the panel.

Mounting dimensions

- Width x height x overall length: 96 x 96 x 121 mm (including terminal board).
- Behind panel length: 114 mm ((including terminal board).
- Cutout in the panel: 91 x 91 mm.
- The thickness of panel: 1, 5 to 10 mm.

Mounting

- Make the panel cutout 91 x 91 mm.
- Slide the controller into the panel cutout.
- Insert the flanges for holding into the holes upward and downward or on both sides of the controller.
- Tighten the screws firmly on the flanges.

The controller is now installed, before wiring we recommend to read thoroughly the chapter on the possible sources of interference and principals for installation.

Wiring of the controller begins on page [22](#).

9.1 Principals for installation, the sources of interference

There are many possible sources of interference in environment of the controller. Among the most harmful sources of interference are the following:

- Equipment with inductive load, e.g. electromotors, winding of relays and breakers, ...
- Thyristors and other semiconductor equipment
- Welding devices.
- Wires carrying high currents.
- Fluorescent lightings and neon lights.

9.2 Reduction of influence of interference

Making a design of system, try to observe these guidelines:

- All wires of power supply voltage and power wires carrying high currents must be lead separately from signal leads (e.g. thermocouple lead wire, communication lines). Minimum distance between these types of wires should not be smaller than 30 cm.
- If signal and power wires cross each other it is suitable for them to be crossed in right angle.
- From the beginning try to find the possible sources of interference and keep the wires away from them.
- Do not install relays and breakers very close to the controller.
- Do not use supply voltage for the controller also for supplying inductive and phase angle control equipment.
- Twisted and shielded wires should be used for signal leads. Shielding should be earthed several times.

When necessary the uninterruptible power sources (UPS) could be used.

10 Wiring

To avoid potential electric shock, use safety practices laid down by national standards when wiring and connecting this unit to a power source. Failure to do so could result in such damage, and / or injury. The wiring must be done only by the authorized person.

If there is any default of the device could cause damage, the equipment with the controller must be fitted with the independent protection unit (thermal cut-out).

Supply voltage

Before you connect the unit to a supply power source, check the level of supply voltage. The controller is intended for use in industrial or in laboratory equipment.

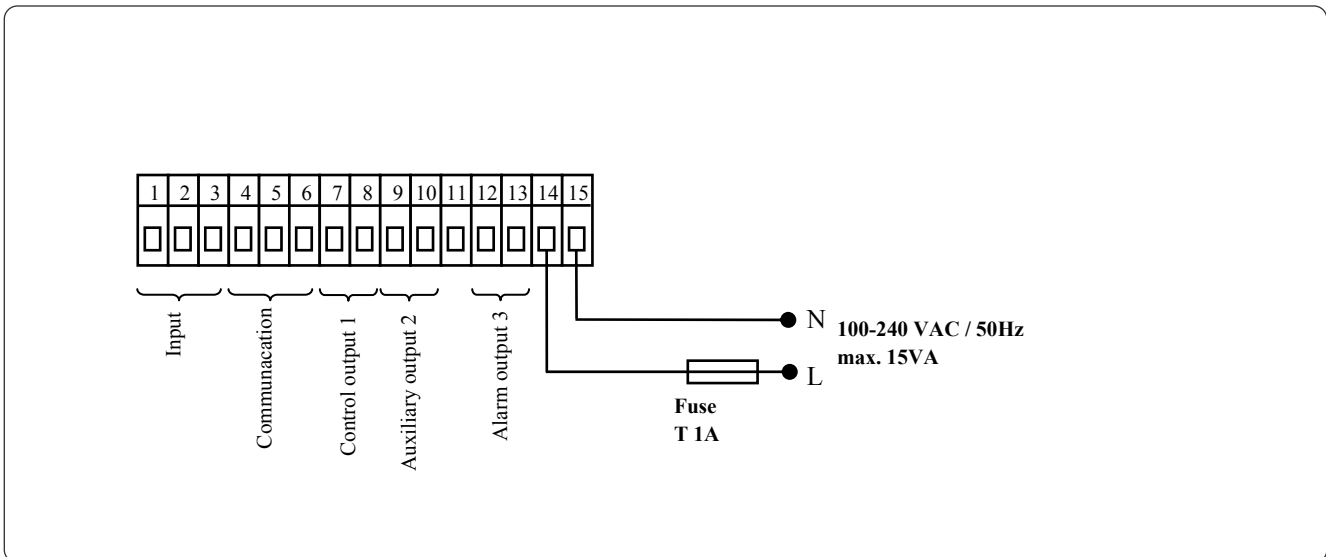

measuring input (InPt1)

Thermal input

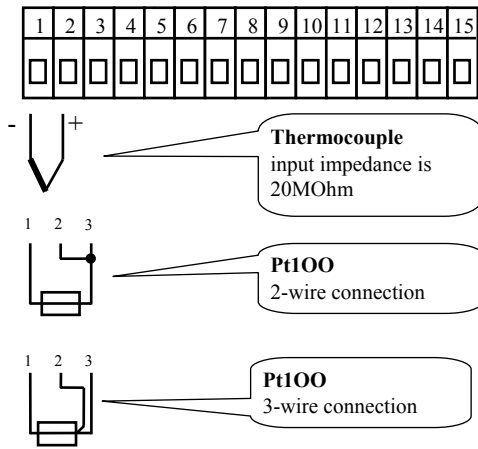

Process input

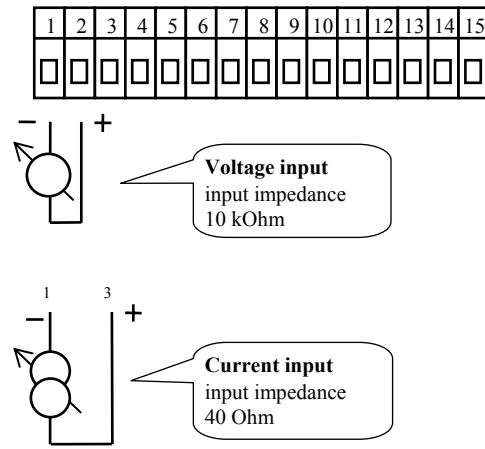

Measuring input is not isolated from the ground of controller

communication line (CoMM)

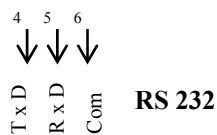
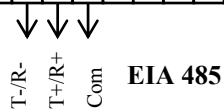
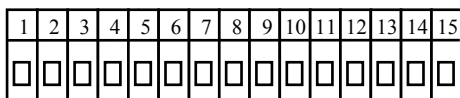

Communication is galvanically isolated from the ground

Com. line RS232 connected to PC

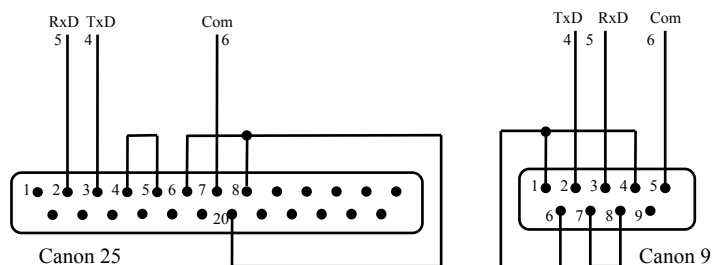

control output 1 (out1)

SSD
dc voltage

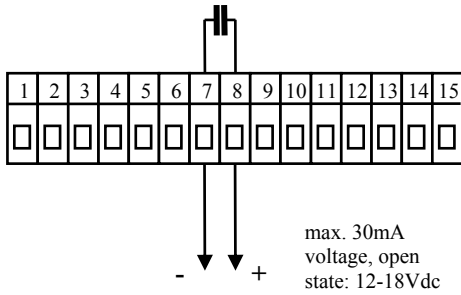

SSD is not isolated from controllers ground

RELAY
Relay output

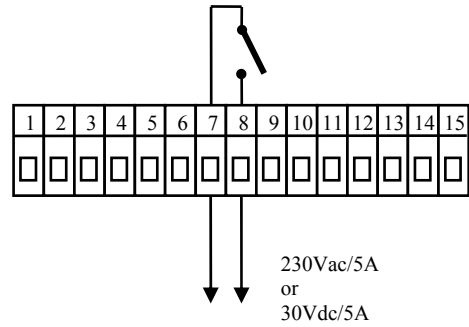

RELAY output is galvanically isolated from the ground of the controller. For this output it is necessary to fix the wires in the way that in case of loosening the wire from the terminal the insulation would not be reduced between supply voltage and safety voltage.

0-10 Vss, 0-5 Vss
Voltage output

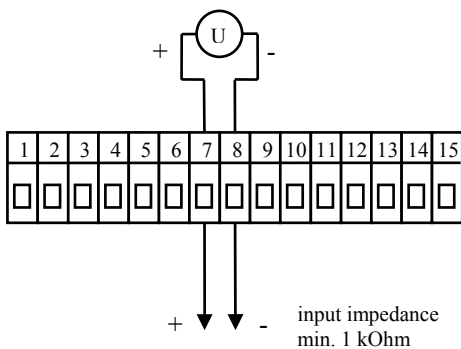

Voltage output is isolated from controllers ground

0-20mA, 4-20mA
Current output

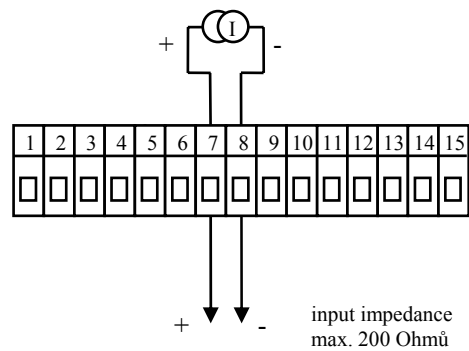

Current output is isolated from controllers ground

auxiliary output 2 (out2)

SSD
dc voltage

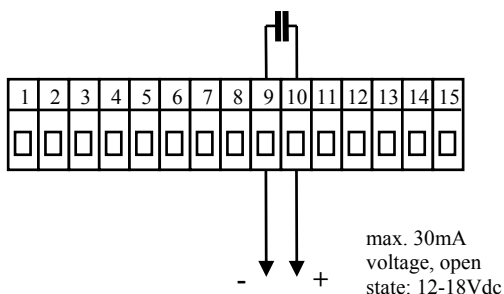

SSD is not isolated from controllers ground

RELAY
Relay output

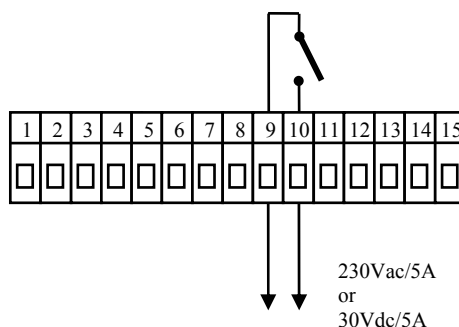

RELAY output is galvanically isolated from the ground of the controller. For this output it is necessary to fix the wires in the way that in case of loosening the wire from the terminal the insulation would not be reduced between supply voltage and safety voltage.

Alarm output

RELAY
Relay output

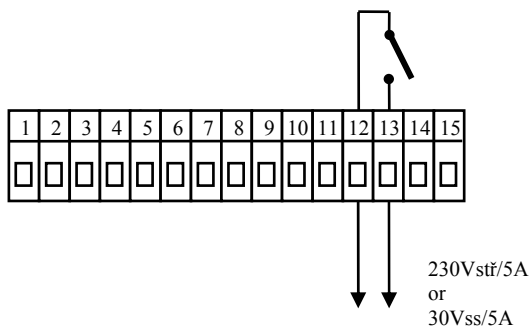

RELAY output is galvanically isolated from the ground of the controller. For this output it is necessary to fix the wires in the way that in case of loosening the wire from the terminal the insulation would not be reduced between supply voltage and safety voltage.

11 Putting into operation

The initial set-up can be done only by the qualified and authorized person.

The wrong set-up can cause serious damage.

When you power the controller up for the first time, you must enter the most necessary data to the controller for its problem-free operation:

- Type of sensor, position of decimal point
- Operational range of set point value
- Set-up for the control output

11.1 Guidelines

Let's suppose that the controller is installed in the panel and you have just power it up for the first time. Parameters of initial operation are the following:

- **SEn1**, set input sensor. The descriptions of this parameter see on page [12](#).
- **dEC1**, set the position of decimal point. You will find the description of this parameter on page [15](#). This parameter is shown only for the process input.
- **r Lo1**, **r hI1**, parameters for setting of the scale of displaying values for process inputs. These are not displayed for thermal inputs. The description of parameters is on page [15](#).
- **out1**, setting of the control output. The descriptions of this parameter see on page [13](#).
- **SP1 Lo**, set low limit of range of stp value. We recommend leaving 0.
- **SP1 hI**, set high limit of range of stp value. We recommend setting maximum working temperature of equipment. The operator can not set higher stp value than this value of parameter.
- Further information about input setting you will find on page [15](#), information about output setting on page [16](#).

Important:

- All the parameters that were set in the initial operation can be later changed in *configuration level*.

12 Technical parameters

The controller is intended for use in industrial or laboratory equipment, the category of overvoltage II.

Controlling

- PID, PI, PD, P controlling, autotuning/automatic setting of PID parameters, controlling of heating.
- ON/OFF controlling, controlling of heating.

Alarm

- absolute alarm, high limit of alarm.

Controlling of stp value

- simple program (rate up and soak or 2 x rate up and soak)
- controlling to constant value.

Indicators and keys

- one 4-figure LED display 14 mm, one 6-figure display 10 mm,
- 3 LED indicating diodes of outputs, 3 LED indicating diodes for program,
- 5 keys, setting is done via menu

Sensors, inputs

Thermal input is thermocouple or rtd, the detection of bad-wired/broken sensor:

- **no** ... no input is set,
- **J** ... thermocouple J, range -200 to 900°C,
- **K** ... thermocouple K, range -200 to 1360°C,
- **T** ... thermocouple T, range -200 to 400°C,
- **N** ... thermocouple N, range -200 to 1300°C,
- **E** ... thermocouple E, range -200 to 700°C,
- **R** ... thermocouple R, range 0 to 1760°C,
- **S** ... thermocouple S, range 0 to 1760°C,
- **B** ... thermocouple B, range 300 to 1820°C,
- **C** ... thermocouple C, range 0 to 2320°C,
- **D** ... thermocouple D, range 0 to 2320°C,
- **rtd** ... sensor rtd (Pt100), range -200 to 800°C, 2 or 3-wire connection, DIN curves.

Process input - current (input impedance 40 Ω), voltage (10 kΩ), without the detection of broken sensor:

- **no** ... no input is set,
- **0-20** ... 0 – 20 mA, range -499 to 2499 units,
- **4-20** ... 4 – 20 mA, range -499 to 2499 units,
- **0-5** ... 0 – 5 V, range -499 to 2499 units,
- **1-5** ... 1 – 5 V, range -499 to 2499 units,
- **0-10** ... 0 – 10 V, range -499 to 2499 units.

Output 1

- ss driver/open collector, 12 – 18 V dc in the state ON, max. 30 mA.
- Electromechanical relay, 230Vac/5A or 30Vdc/5A, switching ON, without RC suppression unit.

Output 2

- ss driver/open collector, 12 – 18 V dc in the state ON, max. 30 mA.
- Electromechanical relay, 230Vac/5A or 30Vdc/5A, switching ON, without RC suppression unit.

Output 3

- Electromechanical relay, 230Vac/5A or 30Vdc/5A, switching ON, without RC suppression unit.

Communication line

- RS 232, galvanically isolated, protocol Modbus RTU,
- EIA 485, galvanically isolated, protocol Modbus RTU.

Accuracy of inputs

- $\pm 0,1\%$ of span/range (min. 540°C), ± 1 digit at $25^{\circ}\text{C} \pm 3^{\circ}\text{C}$ of ambient temperature and at $\pm 10\%$ rated supply voltage,
- temperature stability $\pm 0,1^{\circ}\text{C}/^{\circ}\text{C}$ in ambient,
- voltage stability $\pm 0,01\%/%$ of change in supply voltage.

Supply voltage

- 100 to 240 VAC 50 Hz, internal slow fuse 2 A/250 V,
- input power max. 15 VA,
- data stored in memory upon power failure.

Operating environment

- 0 to 50°C ,
- 0 to 90 % relative humidity, non-condensing.

Shipping and storage

- -20 to 70°C .

Dimensions

- width x height x length 96 x 96 x 121 mm,
- depth behind panel surface 114 mm,
- cutout into the panel 96 x 91 mm, , the thickness of the panel 1,5 to 10 mm.

12.1 Warranty

The supplier provides 36-month warranty on defects in material and workmanship on this controller with the exception on defects caused by mechanical or electrical wearing out of the outputs. This warranty does not also apply to damage resulting from inappropriate transportation and storage, misuse, wrong wiring, ambient influences (especially effects of electrical overvoltage, electrical values and temperatures of inadmissible intensity, chemical materials, mechanical damage) electrical or mechanical overloading of inputs and outputs.

12.2 Description of model

Ht40AL – a b – c d e – f g h

- **a: input**
T = thermal input
P = process input
- **b: communication line**
0 = none
X = communication line RS 232
A = communication line EIA 485
- **c: output 1 (control)**
K = ss driver
R = electromechanical relay
P = current 0-20 mA, 4-20 mA
N = voltage 0-5 V, 0-10 V
- **d: output 2 (auxiliary)**
0 = none
K = ss driver
R = electromechanical relay
- **e: alarm output**
R = electromechanical relay
- **f, g, h: 0 0 0**

13 Index

1	Important.....	2
2	Basic terms.....	3
2.1	Operation and description of controller.....	3
2.2	Information and error messages.....	4
2.3	Overview of levels, menus.....	4
3	Basic mode.....	5
4	Controlling of stp value, program.....	6
4.1	Controlling of stp value.....	6
4.2	Controlling by simple program.....	7
5	Operation level.....	10
5.1	Parameters of the control output, PID controlling.....	11
5.2	Alarm output.....	11
6	Configuration level.....	12
6.1	Measurement.....	15
6.2	Controlling, the control output.....	16
6.3	Function of the output 2.....	18
7	Service level.....	19
8	Table of parameters.....	20
9	Installation.....	21
9.1	Principals for installation, the sources of interference.....	21
9.2	Reduction of influence of interference.....	21
10	Wiring.....	22
11	Putting into operation.....	26
11.1	Guidelines.....	26
12	Technical parameters.....	27
12.1	Warranty.....	29
12.2	Description of model.....	29
13	Index.....	30