

RF EMF Strength Meter

Model 480836

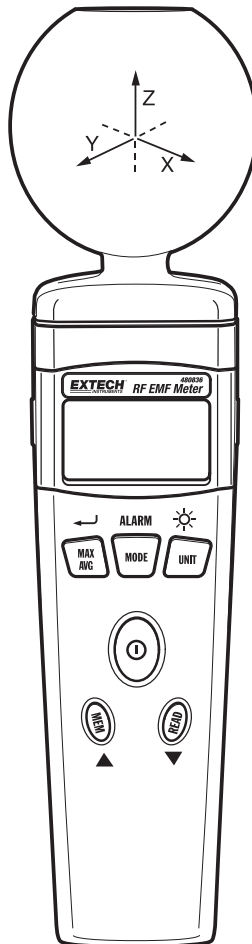

Safety Information



CAUTION

- Before making a measurement, check if the low battery symbol () is shown on the display when the meter is switched on. Replace the battery if the symbol is displayed.
- In the case of prolonged storage, it is preferable to remove the battery from the meter.
- Avoid shaking the meter, particularly in the measurement mode.
- The accuracy and function of the meter may be adversely affected by exceeding the specified limits as well as by improper handling.



DANGER!

- Use caution when working in the vicinity of powerful radiation sources.
- Persons with electronic implants (e.g. cardiac pacemakers) should avoid powerful radiation sources.
- Observe the local safety regulations.
- Observe the operating instructions for equipment that is used to generate or conduct electromagnetic energy.
- Be aware that secondary radiators (e.g. reflective objects such as a metallic fence) can cause a local amplification of the field.
- Be aware that the field strength in the near vicinity of radiators increases proportionally to the inverse cube of the distance. This means that enormous field strengths can result in the immediate vicinity of small radiation sources (e.g. leak in waveguides, inductive ovens).
- Field strength measuring devices can underrate pulsed signals, particularly with radar signals in which case significant measurement errors can arise.
- All field strength measuring devices have a limited specified frequency range. Fields with spectral components outside of this frequency range are generally incorrectly evaluated and tend to be underrated. Before using field strength measuring devices, you should thus be certain that all field components to be measured lie in the specified frequency range of the measuring device.

Introduction

Fundamentals

- **Electromagnetic Radiation**

This meter is used to indicate radiated electromagnetic fields. Wherever there is a voltage or a current, electric (E) and magnetic (H) fields arise. Examples include the electromagnetic fields from radio broadcasting and TV transmitters.

- **Electric Field Strength**

This is a field vector quantity that represents the force (F) on an infinitesimal unit positive test charge (q) at a point divided by that charge. Electric field strength is expressed in units of volts per meter (V/m).

Use the units of electric field strength for measurements in the following situations:

- In the near-field area of the source
- Where the nature of the electromagnetic field is unknown

- **Magnetic field strength (H)**

This is a field vector that is equal to the magnetic flux density divided by the permeability of the medium. Magnetic field strength is expressed in units of amperes per meter (A/m).

- **Power density (S)**

Power per unit area in the direction of propagation, usually expressed in units of watts per square meter (W/m²) or, for convenience, units such as milliwatts per square centimeter (mW/cm²).

- **The characteristic of electromagnetic fields**

Electromagnetic fields propagate as waves and travel at the speed of light (c). The wavelength is proportional to the frequency.

$$\lambda(\text{wavelength}) = \frac{c (\text{speed of light})}{f (\text{frequency})}$$

Near-field is assumed if the distance to the field source is less than three wavelengths. For far-fields, the distance is more than three wavelengths. In the near-field, the ratio of electric field strength (E) and magnetic field strength (H) is not constant, so measure each separately. In the far-field, however, it is enough to just measure one field quantity, and compute the other accordingly.

Application

- High frequency (RF) electromagnetic wave field strength measurement
- Mobile phone base station antenna radiation power density measurement
- Wireless communication applications (CW, TDMA, GSM, DECT)
- RF power measurement for transmitters
- Wireless LAN (Wi-Fi) detection, installation
- Spy camera, wireless bug finder
- Cellular/Cordless phone radiation safety level
- Microwave oven leakage detection
- Personal, environmental EMF safety

Features

This meter is a broadband device for monitoring high-frequency radiation in the specific ranges of 900MHz, 1800MHz, and 2.7GHz. Other measurements can be made, for reference purposes only, using the entire range of 50MHz to 3.5GHz. The non-directional electric field and high sensitivity also allow measurements of electric field strength in TEM cells and absorber rooms.

The unit of measurement and the measurement types are expressed in units of electrical and magnetic field strength and power density.

At high frequencies, the power density is of particular significance. It provides a measure of the power absorbed by a person exposed to the field. This power level must be kept as low as possible at high frequencies. The meter can be set to display the instantaneous value, the maximum value measured or the average value. Instantaneous and maximum value measurements are useful for orientation, e.g. when first entering an exposed area.

- Measurements in the specific frequency ranges of 900MHz, 1800MHz, and 2.7GHz
- For isotropic measurements of electromagnetic fields
- Non-directional (isotropic) measurement with three-channel measurement sensor
- High dynamic range due to three-channel digital processing
- Configurable alarm threshold and memory function

Front Panel Description

(1). **E-field sensor.**

(2). **LCD display.**

(3). **MAX/AVG/↵ key :**

- ① Press this key to scroll through the following: “Instantaneous” → “Max. instantaneous” → “Average” → “Max. average”.
- ② In the read mode, press this key to exit.
- ③ In the alarm setting mode, press this key to store the setting value.
- ④ Press and hold this key while turning the meter on to disable the audible sound. The “•••••” symbol will disappear.

(4). **MODE/ALARM key :**

- ① Press this key to change the sensor axis: “XYZ axis” → “X axis” → “Y axis” → “Z axis”.
- ② Press and hold this key while turning the meter on to switch the device to the alarm setting mode.
- ③ Press this key for 2 seconds to switch the alarm function on or off.

(5). **UNIT/ ☀ key:**

- ① Press this key to change the units: “mV/m or V/m” → “μA/m or mA/m” → “μW/m² or mW/m² or W/m²” → “μW/cm² or mW/cm²”
- ② Press this key for 2 seconds to turn the backlight on. The backlight turns off automatically in 15 seconds later.
- ③ Press and hold this key and turn on the meter again to disable the backlight auto off function.

Note: the meter auto ranges. If RF signals are being measured, not all of the units of measure may appear when you press the Units key.

(6). **⏻ key:** Press this key to turn the meter on or off.

(7). **MEM/▲ key:**

- ① Press this key momentarily to store one data set to memory.
- ② Press and hold this key while turning the meter ON to enter the manual clear recorded data mode.
- ③ In the manual data reading mode, press this key to read the **next** stored data.
- ④ In the alarm setting mode, press this key to **increase** the setting value.





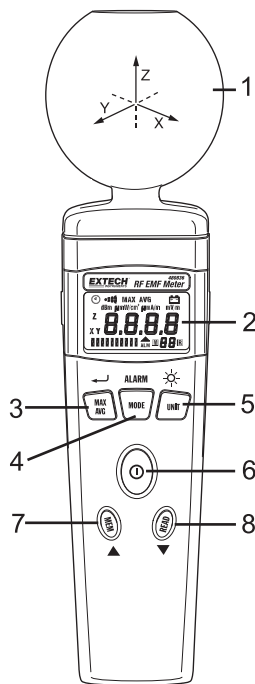

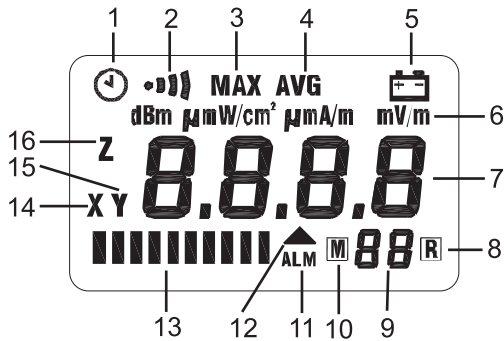

(8). **READ/▼ key:**

- ① Press this key to switch to the manual data reading mode.
- ② Press and hold this key while turning the meter on to disable the auto power off function.
- ③ In the manual data reading mode, press this key to read the **previous** stored data.
- ④ In the alarm setting mode, press this key to **decrease** the setting value.



LCD display description



- (1).  : Auto power off function on / off.
- (2).  : Audible sound function on / off.
- (3). **MAX**: Maximum measured value displayed.
MAX AVG: Maximum average value displayed.
- (4). **AVG**: Average measured value displayed.
- (5).  : Low battery indication.
- (6). **Units** : mV/m and V/m : Electric field strength.
 $\mu\text{A/m}$ and mA/m : Magnetic field strength.
 $\mu\text{W/m}^2$, mW/m^2 , W/m^2 , $\mu\text{W/cm}^2$ and mW/cm^2 : Power density
- (7).  : Measured value displayed as per selected mode and selected units.
- (8).  : Manual data memory mode indication.
- (9).  : Manual data memory address number (1~99).
 : The manual data memory clear mode.
- (10).  : Stored measured value to memory indication.
- (11). **ALM**: Alarm function on / off or alarm setting indication.
- (12).  : Displays when the alarm function is on and the instantaneous measured value exceeds the limit value indication.
- (13).  : Analog bargraph of each axis (X,Y or Z) measured dynamic range indication for observing trends.
- (14). **X**: X axis measured value displayed.
- (15). **Y**: Y axis measured value displayed.
- (16). **Z**: Z axis measured value displayed.

Using E-field sensor

The 3-channel sensor is located at the top of the meter. The three voltages generated by the sensor are fed back to the meter. In far-fields, an E-field sensor is preferable due to the greater bandwidth. The E-field sensor frequency ranges from **50MHz to 3.5GHz** (calibration accuracy only supports measurements in the 900MHz, 1800MHz, and 2.7GHz ranges, other measurements made in the 50MHz to 3.5GHz range are for reference purposes only).

The meter is a small portable instrument that measures the electric field in the atmosphere of the sensor's surroundings. The measurement of the field is done by moving the aerial of the sensor in the desired measured environment.

A direct wide band measurement is obtained of the field that the measurement sensor is subjected to. To find the value of the field emitted by a source of interference, simply point the aerial towards it and get as close as possible (the value of the field is inversely proportional to the distance of the sensor/emission source). The operator must take care not to be between the source of disturbance and the zone to be checked. The human body shields electromagnetic fields. The E-field sensor is isotropic; it does not require special handling. It measures the field according to 3 axes without the aerial having to be moved in the 3 planes. Simply point it at the target to make the measurement.

Explanatory notes

Units of measurement

The meter measures the electrical component of the field; the default units are those of electrical field strength (mV/m, V/m). The meter converts the measurement values to the other units of measurement, i.e. the corresponding magnetic field strength units ($\mu\text{A/m}$, mA/m) and power density units ($\mu\text{W/m}^2$, mW/m², $\mu\text{W/cm}^2$ or mW/cm²) using the standard far-field formulae for electromagnetic radiation.

The conversion is invalid for near-field measurements, as there is no generally valid relationship between electrical and magnetic field strength in this situation. Always use the default units of the sensor when making near-field measurements.

Result modes

The bar graph display always shows each axis (X, Y or Z) the instantaneous measured dynamic range value. The digit display shows the measurement according to one of four selectable modes:

- **Instantaneous:** The display shows the last value measured by the sensor, no symbol is displayed. (RMS Value)
- **Maximum instantaneous (MAX):** The digital display shows the highest instantaneous value measured, the "MAX" symbol is displayed. (PEAK Value)
- **Average (AVG):** The digital display shows the average value measured, the "AVG" symbol is displayed. (RMS Value)
- **Maximum average (MAX AVG):** The digital display shows the highest average value measured, the "MAX AVG" symbol is displayed. (PEAK Value)

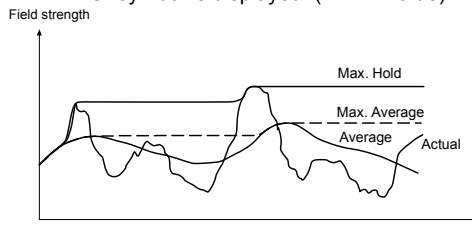

Alarm limit value (ALM)

The alarm limit value is used to monitor the display value and control the alarm indication function. The alarm limit value can be edited in the displayed V/m unit; the smallest value that can be set is 0.05V/m.

NOTE: Alarm limit function can only be used for the total three axial measurement value.

Calibration Factor (CAL)

The calibration factor "CAL" corrects for variances in the frequency response of the field sensor. When a known RF calibration source is not available for precise calibration, a calibration factor of 1.00 is sufficient for most applications.

E-Field typically calibration data:

| Frequency | CAL |
|-----------|------|
| 50MHz | 3.16 |
| 100MHz | 2.46 |
| 200MHz | 2.01 |
| 300MHz | 1.91 |
| 433MHz | 0.55 |
| 500MHz | 0.37 |
| 600MHz | 2.41 |
| 700MHz | 4.63 |
| 800MHz | 4.21 |
| 900MHz | 4.47 |
| 1GHz | 2.80 |
| 1.2GHz | 1.38 |
| 1.4GHz | 3.26 |
| 1.6GHz | 1.25 |
| 1.8GHz | 1.87 |
| 2GHz | 1.67 |
| 2.2GHz | 1.95 |
| 2.45GHz | 1.93 |

Setting the meter

Setting the units of measurement
Use the UNIT key as follows.

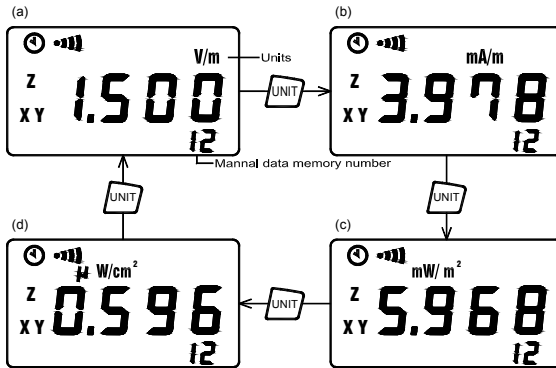

- Electric field strength (V/m).
- Computed magnetic field strength (mA/m).
- Computed power density (mW/m^2).
- Computed power density ($\mu W/cm^2$).

Setting the result mode

Instantaneous result mode is automatically set when the meter is turned on.
With the MAX/AVG key as follows:

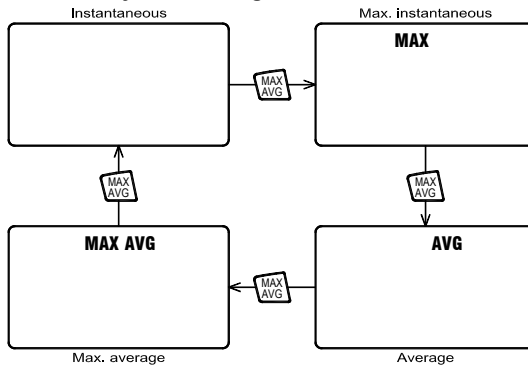

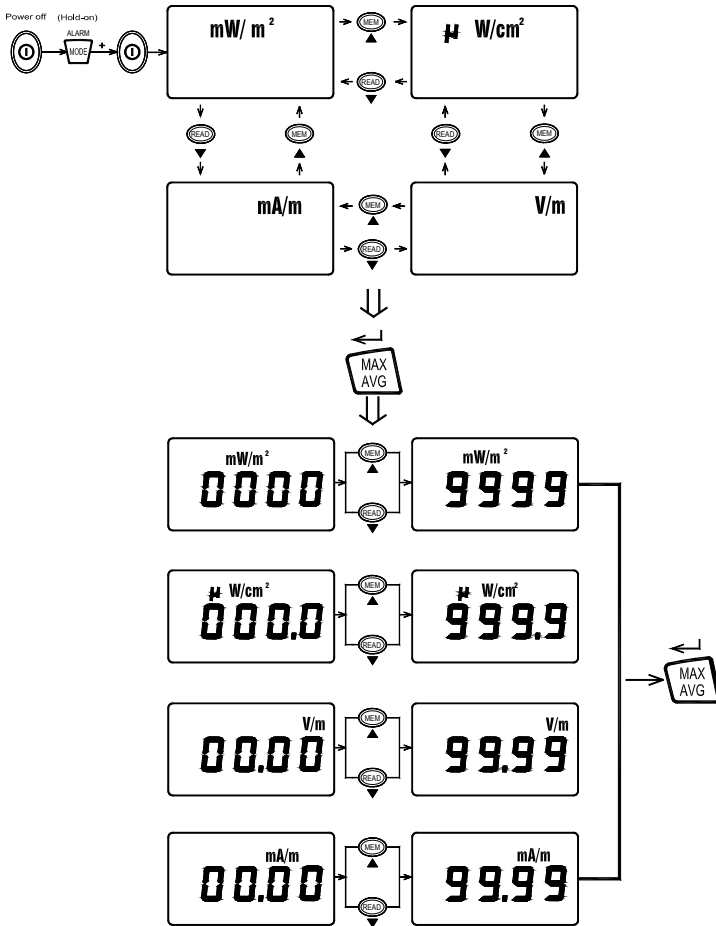

Setting the alarm limit value (ALM)

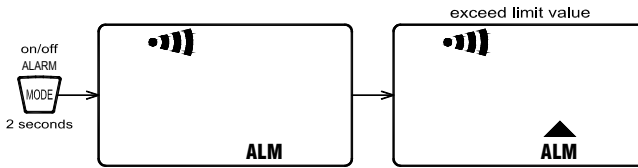

1. Press **⓪** key to turn off the meter.
2. Press and hold the **MODE** key, then momentarily press **⓪** key to turn on the meter. Release the MODE key, the display is now in Alarm set mode.
3. The units of measure will be flashing. Press **▼** or **▲** keys to choose the Units of measure. Press **↵** key to store the selected units of measure. The flashing digit can now be changed.
4. Press **▼** or **▲** keys to increase or decrease the value. Press **↵** key to select the next digit.
5. When all 4 of the digits have been selected, Press **↵** key to store the new setting value and exit.

Switching the alarm function on or off



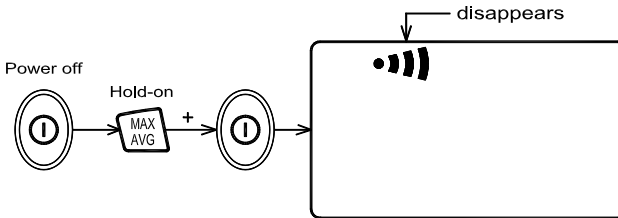

1. Press **ALARM** key for 2 seconds to switch the alarm function on or off. The “ALM” and “” symbols in the display indicates that the alarm function is on.
2. When the alarm function is on, the display will show “▲” if the instantaneous measured value exceeds the limit value.

Setting the audible sound function off





When the meter is normally turned on, the audible sound function is on.

1. Press  key to turn off the meter.
2. Press and hold **MAX/AVG** key and turn on the meter again to disable the audible sound, the “” symbol will disappear from the display.

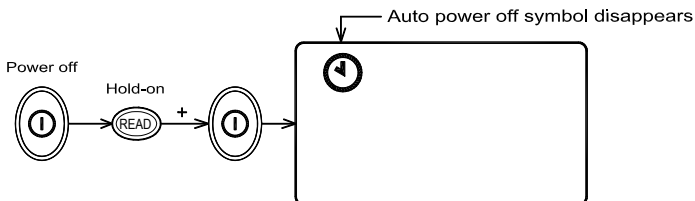
Setting the auto power off function off





When the meter is normally turned on, the auto power off function is on.

1. Press  key to turn off the meter.
2. Press and hold **READ** key and turn on the meter again to disable the auto power off function; the “” symbol will disappear from the display.

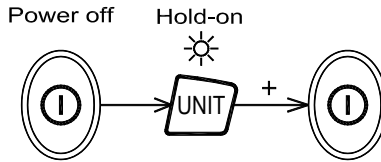





Setting the backlight auto off function off

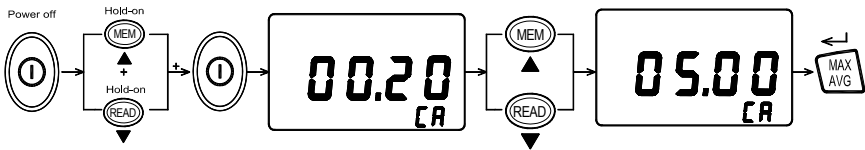

1. Press  key to turn off the meter.
2. Press and hold  key and turn on the meter again to disable the backlight auto off function.

Setting the calibration factor (CAL)



1. Press the  key turn to off the meter.
2. Press and hold down the  and  keys, then press the  key to turn on the meter, the display then shows “CA” (The Calibration factor setting mode).
3. Simultaneously press the  or  key to increase or decrease the value.
4. Press the  key to store the new setting value and exit.

Making measurements

Important:

If the sensor is moved quickly, excessive field strength values will be displayed which do not reflect the actual field conditions. This effect is caused by electrostatic charges.

Recommendation:

Hold the meter steady during the measurement.

Short-term measurements

Application:

Use either the “Instantaneous” or the “Max. Instantaneous” mode if the characteristics and orientation of the field are unknown when entering an area exposed to electromagnetic radiation.

Procedure

1. Hold the meter at arm's length.
2. Make several measurements at various locations around the work place or the interested areas as described above. This is particularly important if the field conditions are unknown.
3. Pay special attention to measuring the neighboring vicinity for possible radiation sources. Apart from active sources, those components connected to a source may also act as radiators. For example, the cables used in diathermy equipment may also radiate electromagnetic energy. Note that metallic objects within the field may locally concentrate or amplify the field from a distant source.

Long-term exposure measurements

Location:

Place the meter between yourself and the suspected source of radiation. Make measurements at those points where parts of your body are nearest to the source of radiation.

Note: Use the "Average" or "Max average" modes only when the instantaneous measurement values are fluctuating greatly.

Alarm function

Use this feature in the "Instantaneous", "Max. Instantaneous", "Average" or "Max. Average" modes.

When the instantaneous measured value exceeds the limit value, a sequence of warning beeps will sound.

Storing readings

The meter includes a non-volatile data memory that can store a maximum of 99 measured values.

Storing individual measured values

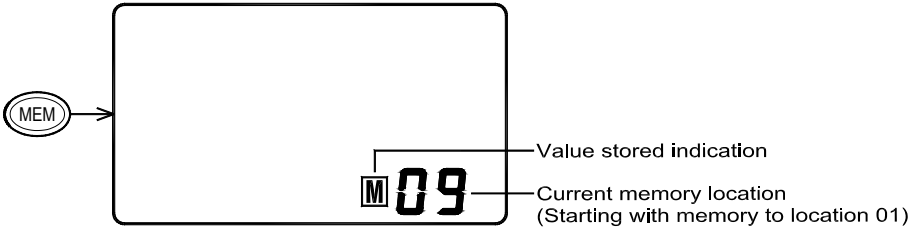

The current memory location number appears in the lower right small display.

Once you press the **MEM** key, it will store a displayed value and increment the memory location by one. Each flash of the “M” symbol display indicates one reading has been stored. When the memory location number shows “99”, to indicate the manual data memory is full, the user must clear the entire contents of the data memory before storing new values.

Reading individual measured values

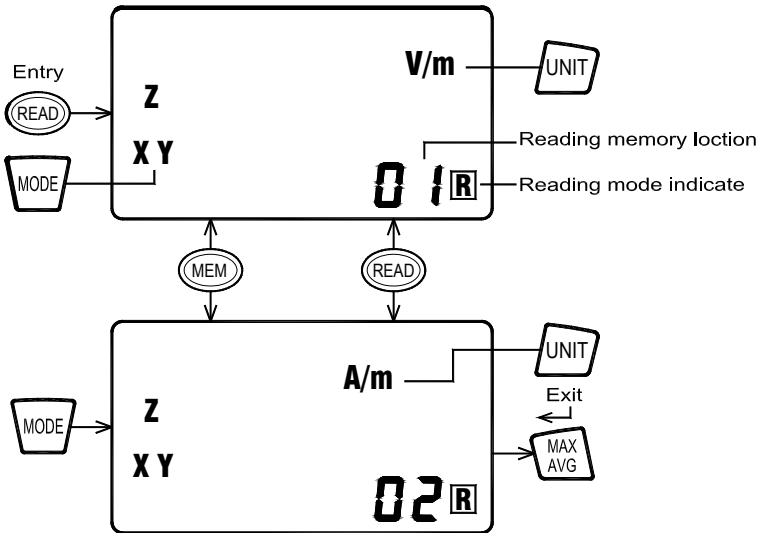

1. Press **READ** key, the display shows “**R**” (reading mode).
2. Press **▼** or **▲** key to select the desired memory location.
3. Press **UNIT** key to select the desired reading units.
4. Press **MODE** key to select the desired sensor axis reading.
5. Press **MAX** key to exit.

Deleting stored values

Once the memory is full, the entire contents of the memory can be cleared.

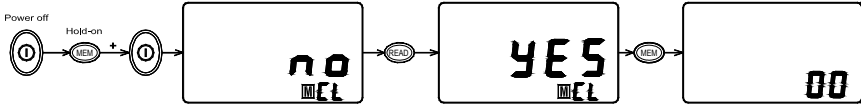

1. Press **⏻** to turn off the meter.
2. Press and hold **MEM** and turn on the meter again; the display will show:

“**MEM**” and “**no**”.

3. Press **▼** to select “**YES**”.

4. Press **▲** to clear memory.

Specifications

General Specifications

- **Measurement method:** Digital, triaxial measurement.
- **Directional characteristic:** Isotropic, triaxial.
- **Measurement ranges:** One continuous range
- **Display resolution:** 0.1mV/m, 0.1 μ A/m, 0.1 μ W/m², 0.001 μ W/cm²
- **Setting time:** Typically 1s (0 to 90% of measurement value).
- **Display refresh rate:** Typically 0.5 seconds
- **Display type:** 4-digit Liquid-crystal display (LCD)
- **Audible alarm:** Buzzer.
- **Units:** mV/m, V/m, μ A/m, mA/m, μ W/m², mW/m², W/m², μ W/cm², mW/cm²
- **Display value:** Instantaneous measured value, maximum value, or maximum average value.
- **Alarm function:** Adjustable threshold with ON/OFF.
- **Manual data memory and read storage:** 99 data sets.
- **Dry batteries:** 9V NEDA 1604/1604A
- **Battery life:** > 15 hours
- **Auto power off:** 15 minutes.
- **Operating temperature range:** 0°C to +50°C
- **Operating humidity range:** 25% to 75%RH
- **Storage temperature range:** -10°C to +60°C
- **Storage humidity range:** 0% to 80%RH
- **Dimensions:** Approx. 60(W) \times 60(T) \times 237(L)mm.
- **Weight (including battery):** Approx. 200g
- **Accessories:** Instruction manual, battery, carrying case.

Electrical Specifications

- ❑ **Unless otherwise stated, the following specifications hold under the following conditions:**
 - The meter is located in the far-field of a source, the sensor head is pointed towards the source.
 - Ambient temperature: $+23\text{C}\pm 3\text{C}$
 - Relative air humidity: 25% to 75%
- ❑ **Sensor type:** Electrical field (E)
- ❑ **Frequency ranges:** 900MHz, 1800MHz, and 2.7GHz (measurements can be made, for reference purposes only, using the entire range of 50MHz to 3.5GHz)
- ❑ **Specified measurement range:**
 - **CW signal (f > 900MHz):** 20mV/m to 108.0V/m ,
53 μ A/m to 286.4mA/m,
1 μ W/m² to 30.93W/m²,
0 μ W/cm² to 3.093mW/cm²
- ❑ **Dynamic range:** Typically 75dB
- ❑ **Absolute error at 1 V/m and 50 MHz:** $\pm 1.0\text{dB}$
- ❑ **Frequency response:**
 - **Sensor (taking into account typical CAL factors):**
 $\pm 1.0\text{dB}$ (900MHz, 1800MHz)
 $\pm 2.4\text{dB}$ (2.7GHz)
 - **Isotropy deviation:** Typically $\pm 1.0\text{dB}$ (f>900MHz)
 - **Overload limit:** 10.61mW/cm² (200V/m)
 - **Thermal response (0 to 50C):** $\pm 0.2\text{dB}$

Battery Installation and Replacement

Battery Loading

Remove the rear battery cover and insert a fresh 9V battery.

Battery Replacement

When the battery voltage drops below the operating voltage, the battery icon  appears and flashes. If it appears, the battery should be replaced.



You, as the end user, are legally bound (**EU Battery ordinance**) to return all used batteries, **disposal in the household garbage is prohibited!** You can hand over your used batteries / accumulators at collection points in your community or wherever batteries / accumulators are sold!

Disposal: Follow the valid legal stipulations in respect of the disposal of the device at the end of its lifecycle

Copyright © 2014-2016 FLIR Systems, Inc.

All rights reserved including the right of reproduction in whole or in part in any form

www.extech.com